

**INSTRUCTION MANUAL**  
**4240 SERIES**  
**RF POWER METER**

REV DATE 01/19/2011  
**MANUAL P/N 98406700A**  
CD P/N 98406799A



Wireless Telecom Group  
25 EASTMANS ROAD, PARSIPPANY, NJ 07054  
**Telephone: 973-386-9696**  
**Fax: 973-386-9191**  
**Email: [boonton@boonton.com](mailto:boonton@boonton.com)**  
**Web: [www.wtcom.com](http://www.wtcom.com)**

# Boonton 4240 Series RF Power Meter

## **INSTRUCTION MANUAL, 4240 SERIES RF POWER METER**

Revision date 01/19/2011

© Copyright in 2005-2011, by BOONTON Electronics, a subsidiary of the Wireless Telecom Group, Inc.

Parsippany, NJ, USA. All rights reserved.

P/N 98406700A

This manual covers instrument serial numbers: 11001 and higher.

K-Connector® is a registered trademark of Anritsu Corporation.

# Boonton 4240 Series RF Power Meter

## **SAFETY SUMMARY**

The following general safety precautions must be observed during all phases of operation and maintenance of this instrument. Failure to comply with these precautions or with specific warnings elsewhere in this manual violates safety standards of design, manufacture, and intended use of the instrument. Boonton Electronics assumes no liability for the customer's failure to comply with these requirements.

### **THE INSTRUMENT MUST BE GROUNDED**

To minimize shock hazard the instrument chassis and cabinet must be connected to an electrical ground. The instrument is equipped with a NEMA three conductor, three prong power cable. The power cable must either be plugged into an approved three-contact electrical outlet or used with a three-contact to a two-contact adapter with the (green) grounding wire firmly connected to an electrical ground in the power outlet.

### **DO NOT OPERATE THE INSTRUMENT IN AN EXPLOSIVE ATMOSPHERE**

Do not operate the instrument in the presence of flammable gases or fumes.

### **KEEP AWAY FROM LIVE CIRCUITS**

Operating personnel must not remove instrument covers. Component replacement and internal adjustments must be made by qualified maintenance personnel. Do not replace components with the power cable connected. Under certain conditions dangerous voltages may exist even though the power cable was removed, therefore; always disconnect power and discharge circuits before touching them.

### **DO NOT SERVICE OR ADJUST ALONE**

Do not attempt internal service or adjustment unless another person, capable of rendering first aid and resuscitation, is present.

### **DO NOT SUBSTITUTE PARTS OR MODIFY INSTRUMENT**

Do not install substitute parts or perform any unauthorized modifications on the instrument. Return the instrument to Boonton Electronics for repair to ensure that the safety features are maintained.

# Boonton 4240 Series RF Power Meter

## SAFETY SYMBOLS



This safety requirement symbol (located on the rear panel) has been adopted by the International Electro-technical Commission, Document 66 (Central Office) 3, Paragraph 5.3, which directs that an instrument be so labeled if, for the correct use of the instrument, it is necessary to refer to the instruction manual. In this case it is recommended that reference be made to the instruction manual when connecting the instrument to the proper power source. Verify that the correct fuse is installed for the power available.



The CAUTION symbol denotes a hazard. It calls attention to an operational procedure, practice or instruction that, if not followed, could result in damage to or destruction of part or all of the instrument and accessories. Do not proceed beyond a CAUTION symbol until its conditions are fully understood and met.



The NOTE symbol is used to mark information which should be read. This information can be very useful to the operating in dealing with the subject covered in this section.



The HINT symbol is used to identify additional comments which are outside of the normal format of the manual, however can give the user additional information about the subject.

# Boonton 4240 Series RF Power Meter

|                                                         |            |
|---------------------------------------------------------|------------|
| <b>1. General Information.....</b>                      | <b>1-1</b> |
| 1.1 Organization.....                                   | 1-1        |
| 1.2 Description.....                                    | 1-2        |
| 1.3 Features.....                                       | 1-2        |
| 1.4 Accessories .....                                   | 1-5        |
| Standard .....                                          | 1-5        |
| Optional.....                                           | 1-5        |
| Sensors.....                                            | 1-5        |
| 1.5 Models, Options and Configurations.....             | 1-5        |
| 1.6 Specifications.....                                 | 1-6        |
| SENSOR INPUTS .....                                     | 1-6        |
| FEATURES .....                                          | 1-6        |
| UNCERTAINTIES .....                                     | 1-7        |
| MEASUREMENT SYSTEM .....                                | 1-7        |
| CALIBRATION SOURCE.....                                 | 1-7        |
| EXTERNAL INTERFACES .....                               | 1-8        |
| PHYSICAL AND ENVIRONMENTAL CHARACTERISTICS .....        | 1-8        |
| OTHER CHARACTERISTICS.....                              | 1-9        |
| REGULATORY CHARACTERISTICS .....                        | 1-9        |
| <b>2. Installation.....</b>                             | <b>2-1</b> |
| 2.1 Unpacking & Repacking.....                          | 2-1        |
| 2.2 Power Requirements .....                            | 2-2        |
| 2.3 Connections .....                                   | 2-2        |
| 2.4 Preliminary Check .....                             | 2-3        |
| <b>3. Getting Started.....</b>                          | <b>3-1</b> |
| 3.1 Organization.....                                   | 3-1        |
| 3.2 Operating Controls, Indicators and Connections..... | 3-1        |
| 3.3 Operation .....                                     | 3-6        |
| 3.3.1 Menu Key.....                                     | 3-9        |
| 3.3.2 Sensor Key.....                                   | 3-15       |
| 3.3.3 FREQ Key.....                                     | 3-19       |
| 3.3.4 AVG Key.....                                      | 3-19       |
| 3.3.5 Zero/Cal Key (single key press operation).....    | 3-19       |
| 3.3.6 REL Level Key (single key press operation).....   | 3-20       |
| <b>4. Operation.....</b>                                | <b>4-1</b> |
| 4.1 Sensor Calibration.....                             | 4-1        |
| 4.2 Zeroing.....                                        | 4-1        |

# Boonton 4240 Series RF Power Meter

|           |                                        |            |
|-----------|----------------------------------------|------------|
| 4.3       | Dynamic Range.....                     | 4-4        |
| 4.4       | Filtering.....                         | 4-5        |
| 4.5       | Noise .....                            | 4-5        |
| 4.6       | Measurement Time .....                 | 4-10       |
| 4.7       | High Frequency Accuracy .....          | 4-11       |
| 4.8       | Waveform Sensitivity .....             | 4-12       |
| 4.9       | Chart Recorder Operation.....          | 4-14       |
| 4.10      | Bar Graph Operation.....               | 4-14       |
| <b>5.</b> | <b>Remote Operation.....</b>           | <b>5-1</b> |
| 5.1       | GPIB Configuration.....                | 5-1        |
| 5.2       | RS-232 Configuration.....              | 5-1        |
| 5.3       | SCPI Language .....                    | 5-2        |
| 5.3.1     | SCPI Structure .....                   | 5-2        |
| 5.3.2     | Long and Short Form Keywords.....      | 5-2        |
| 5.3.3     | Subsystem Numeric Suffixes.....        | 5-2        |
| 5.3.4     | Colon Keyword Separators.....          | 5-3        |
| 5.3.5     | Command Arguments and Queries.....     | 5-3        |
| 5.3.6     | Semicolon Command Separators.....      | 5-3        |
| 5.3.7     | Command Terminators .....              | 5-3        |
| 5.3.8     | 4240 Series SCPI Implementation.....   | 5-3        |
| 5.4       | Basic Measurement Information.....     | 5-5        |
| 5.4.1     | Service Request.....                   | 5-5        |
| 5.5       | SCPI Command Reference .....           | 5-6        |
| 5.5.1     | IEEE 488.2 Commands.....               | 5-6        |
|           | *CLS .....                             | 5-6        |
|           | *ESE .....                             | 5-6        |
|           | *ESR? .....                            | 5-7        |
|           | *IDN?.....                             | 5-7        |
|           | *OPC.....                              | 5-7        |
|           | *OPC?.....                             | 5-7        |
|           | *OPT? .....                            | 5-8        |
|           | *RST .....                             | 5-8        |
|           | *SRE .....                             | 5-8        |
|           | *STB? .....                            | 5-9        |
|           | *TRG.....                              | 5-9        |
|           | *TST?.....                             | 5-9        |
|           | *WAI.....                              | 5-9        |
| 5.5.2     | CALCulate Subsystem.....               | 5-10       |
|           | CALCulate:LIMit:CLEar[:IMMediate]..... | 5-10       |
|           | CALCulate:LIMit:FAIL?.....             | 5-10       |

# Boonton 4240 Series RF Power Meter

|                                   |      |
|-----------------------------------|------|
| CALCulate:LIMit:LOWer[:POWer]     | 5-10 |
| CALCulate:LIMit:UPPer[:POWer]     | 5-11 |
| CALCulate:LIMit:LOWer:STATe       | 5-11 |
| CALCulate:LIMit:UPPer:STATe       | 5-11 |
| CALCulate:LIMit[:BOTH]:STATe      | 5-11 |
| CALCulate:MATH:ARGA               | 5-12 |
| CALCulate:MATH:ARGB               | 5-12 |
| CALCulate:MATH:DATA?              | 5-12 |
| CALCulate:MATH:OPERator           | 5-12 |
| CALCulate:MODE                    | 5-12 |
| CALCulate:REFerence:COLLect       | 5-13 |
| CALCulate:REFerence:DATA          | 5-13 |
| CALCulate:REFerence:STATe         | 5-13 |
| CALCulate:STATe                   | 5-13 |
| CALCulate:UNITs                   | 5-13 |
| 5.5.3 CALibration Subsystem       | 5-14 |
| CALibration:AUTOcal               | 5-14 |
| CALibration:FIXedcal              | 5-14 |
| CALibration:ZERO                  | 5-14 |
| 5.5.4 DISPlay Subsystem           | 5-15 |
| DISPlay:ACTive[?]                 | 5-15 |
| DISPlay:CLear                     | 5-15 |
| DISPlay:LIN:RESolution            | 5-15 |
| DISPlay:LOG:RESolution            | 5-15 |
| DISPlay:LABEL:MODE                | 5-15 |
| DISPlay:LABEL:TEXTA               | 5-16 |
| DISPlay:LABEL:TEXTB               | 5-16 |
| DISPlay:LABEL:TEXTC               | 5-16 |
| DISPlay:LABEL:TEXTD               | 5-16 |
| 5.5.5 FETCh Queries               | 5-17 |
| FETCh:CW:POWer?                   | 5-17 |
| FETCh:KEY?                        | 5-17 |
| 5.5.6 INITiate and ABORt Commands | 5-18 |
| ABORt                             | 5-18 |
| INITiate:CONTinuous               | 5-18 |
| INITiate[:IMMediate[:ALL]]        | 5-18 |
| 5.5.7 MEASure Queries             | 5-19 |
| MEASure:POWer?                    | 5-19 |
| MEASure:VOLTagE?                  | 5-19 |
| 5.5.8 MEMory Subsystem            | 5-20 |
| MEMory:SNSR:CF?                   | 5-20 |
| MEMory:SNSR:CWRG?                 | 5-20 |
| MEMory:SNSR:INFO?                 | 5-20 |
| MEMory:SYS:LOAD                   | 5-20 |
| MEMory:SYS:STORe                  | 5-20 |
| 5.5.9 OUTPut Subsystem            | 5-21 |

# Boonton 4240 Series RF Power Meter

|                                             |      |
|---------------------------------------------|------|
| OUTPut:LEVel[:POWer]                        | 5-21 |
| OUTPut:SIGNal                               | 5-21 |
| OUTPut:RECOder:FORCe                        | 5-21 |
| OUTPut:RECOder:MAX                          | 5-21 |
| OUTPut:RECOder:MIN                          | 5-21 |
| OUTPut:RECOder:SOURce                       | 5-22 |
| 5.5.10 READ Queries                         | 5-23 |
| READ:CW:POWer?                              | 5-23 |
| 5.5.11 SENSE Subsystem                      | 5-24 |
| SENSe:CORRection:CALFactor                  | 5-24 |
| SENSe:CORRection:DCYClE                     | 5-24 |
| SENSe:CORRection:FREQuency                  | 5-24 |
| SENSe:CORRection:OFFSet                     | 5-24 |
| SENSe:FILTer:STATe                          | 5-25 |
| SENSe:FILTer:TIME                           | 5-25 |
| 5.5.12 STATus Commands                      | 5-26 |
| STATus:DEVice:CONDition?                    | 5-26 |
| STATus:DEVice:ENABle                        | 5-26 |
| STATus:DEVice:EVENt?                        | 5-27 |
| STATus:DEVice:NTRAnsiTion                   | 5-27 |
| STATus:DEVice:PTRAnsiTion                   | 5-27 |
| STATus:OPERation:CONDition?                 | 5-28 |
| STATus:OPERation:ENABle                     | 5-28 |
| STATus:OPERation:EVENt?                     | 5-28 |
| STATus:OPERation:NTRAnsiTion                | 5-29 |
| STATus:OPERation:PTRAnsiTion                | 5-29 |
| STATus:PRESet                               | 5-29 |
| STATus:QUEStionable:CONDition?              | 5-30 |
| STATus:QUEStionable:ENABle                  | 5-30 |
| STATus:QUEStionable:EVENt?                  | 5-30 |
| STATus:QUEStionable:NTRAnsiTion             | 5-31 |
| STATus:QUEStionable:PTRAnsiTion             | 5-31 |
| STATus:QUEStionable:CALibration:CONDition?  | 5-31 |
| STATus:QUEStionable:CALibration:ENABle      | 5-32 |
| STATus:QUEStionable:CALibration:EVENt?      | 5-32 |
| STATus:QUEStionable:CALibration:NTRAnsiTion | 5-32 |
| STATus:QUEStionable:CALibration:PTRAnsiTion | 5-32 |
| 5.5.13 SYSTem Subsystem                     | 5-33 |
| SYSTem:BEEP[:ENABle]                        | 5-33 |
| SYSTem:BEEP:IMMediate                       | 5-33 |
| SYSTem:COMMunicate:GPIB:ADDReSS             | 5-33 |
| SYSTem:COMMunicate:GPIB:EOI                 | 5-33 |
| SYSTem:COMMunicate:GPIB:LISTen              | 5-33 |
| SYSTem:COMMunicate:GPIB:TALK                | 5-34 |
| SYSTem:COMMunicate:SERial:BAUD              | 5-34 |
| SYSTem:COMMunicate:SERial:BITS              | 5-34 |



# Boonton 4240 Series RF Power Meter

|                                                  |            |
|--------------------------------------------------|------------|
| SYSTem:COMMunicate:SERial:PARity .....           | 5-34       |
| SYSTem:COMMunicate:SERial:SBITs .....            | 5-34       |
| SYSTem:ERRor[:NEXT]? .....                       | 5-35       |
| SYSTem:ERRor:CODE? .....                         | 5-35       |
| SYSTem:ERRor:COUNt? .....                        | 5-35       |
| SYSTem:PRESet .....                              | 5-35       |
| SYSTem:VERSion? .....                            | 5-35       |
| 5.5.14 INSTrument:VERSion Commands .....         | 5-36       |
| INSTrument:VERSion:FIRMware? .....               | 5-36       |
| INSTrument:VERSion:FPGA? .....                   | 5-36       |
| 5.5.15 SCPI Command Summary .....                | 5-37       |
| 5.5.16 4230 Emulation GPIB Commands .....        | 5-42       |
| 5.5.17 HP 437B Emulation GPIB Commands .....     | 5-44       |
| 5.5.18 HP 438A Emulation GPIB Commands .....     | 5-47       |
| <b>6. Application Notes .....</b>                | <b>6-1</b> |
| 6.1 Pulse Measurements .....                     | 6-1        |
| 6.1.1 Measurements Fundamentals .....            | 6-1        |
| 6.1.2 Diode Detection .....                      | 6-3        |
| 6.1.3 4240 Series Features .....                 | 6-4        |
| 6.2 Measurement Accuracy .....                   | 6-5        |
| 6.2.1 Uncertainty Contributions .....            | 6-5        |
| 6.2.2 Discussion of Uncertainty Terms .....      | 6-6        |
| 6.2.3 Sample Uncertainty Calculations .....      | 6-9        |
| <b>7. Maintenance .....</b>                      | <b>7-1</b> |
| 7.1 Safety .....                                 | 7-1        |
| 7.2 Cleaning .....                               | 7-1        |
| 7.3 Inspection .....                             | 7-1        |
| 7.4 Firmware Upgrade .....                       | 7-1        |
| 7.5 Firmware Upgrade Instructions .....          | 7-2        |
| <b>8. Appendix A SCPI Error Messages .....</b>   | <b>8-1</b> |
| 8.1 SCPI Error Messages .....                    | 8-1        |
| <b>9. Appendix B Warranty &amp; Repair .....</b> | <b>9-1</b> |
| Repair Policy .....                              | 9-1        |
| Limited Warranty .....                           | 9-1        |

# Boonton 4240 Series RF Power Meter

This page intentionally left blank.

## 1. General Information

This instruction manual provides you with the information you need to install, operate and maintain the Boonton 4240 Series RF Power Meter. Section 1 is an introduction to the manual and the instrument.

Throughout this manual, the designation “4240” will be used to mean the 4240 Series RF Power Meter, which includes both the single-channel Model 4241 and the dual-channel Model 4242.

### 1.1 Organization

The manual is organized into seven sections and three Appendices, as follows:

**Section 1 - General Information** presents summary descriptions of the instrument and its principal features, accessories and options. Also included are specifications for the instrument.

**Section 2 - Installation** provides instructions for unpacking the instrument, setting it up for operation, connecting power and signal cables, and initial power-up.

**Section 3 - Getting Started** describes the controls and indicators and the initialization of operating parameters. Several practice exercises are provided to familiarize you with essential setup and control procedures.

**Section 4 - Operation** describes the display menus and procedures for operating the instrument locally from the front panel.

**Section 5 - Remote Operation** explains the command set and procedures for operating the instrument remotely over GPIB bus.

**Section 6 - Application Notes** describes automatic measurement procedures and presents an analysis of measurement accuracy. Definitions are provided for key terms used in this manual and on the screen displays.

**Section 7 - Maintenance** includes procedures for installing software and verifying fault-free operation.

**Section 8 - Appendix A - Error Messages** defines the messages that are displayed when errors occur.

**Section 9 - Appendix B - Warranty and Repair Policy** states the policies governing the return and replacement of modules and instruments during and after the warranty period.

# Boonton 4240 Series RF Power Meter

## 1.2 Description

The Model 4240 is a digital signal processor based, single or dual channel, solid state RF power meter. It is capable of measuring RF power levels from -70 dBm to +44 dBm. The frequency range and power level are sensor dependent. Boonton 51000 series sensors provide measurement capabilities for frequencies from 10 kHz to 100 GHz. The 4240 is available as the single-channel Model 4241 or the dual-channel Model 4242.

## 1.3 Features

- *Software.* A 32-bit Digital Signal Processor running control software provides display, I/O and system memory functions for the instrument. Software updates are easily made using either the GPIB or RS232 interfaces.
- *Alphanumeric Display.* The alphanumeric LCD provides clear, unambiguous readouts of the instrument's setup and measurement values. Simultaneous display of both channels is available in dual channel mode. A bar graph provides a display of the channel's measured value for nulling and peaking applications.



Figure 1-1. 4240 Series RF Power Meter

# Boonton 4240 Series RF Power Meter

- *Dual Independent Channels.* When equipped with the optional second measurement channel, the instrument can display two CW signals simultaneously. Each channel is calibrated and all channel parameters are channel-independent.
- *Selectable Ranging.* Any of seven measurement ranges, or autoranging, can be selected during instrument setup. The selection will be held until it is changed, or until the instrument is turned off. When measuring signals with levels that fall within a narrow range, selecting one specific instrument range may reduce measurement time. Autoranging is useful if the RF signal level is unknown, or if RF signals with widely varying levels are to be measured.
- *Selectable Filtering.* Measurement speed and display stability can be optimized through the use of selectable filtering. Filter times can be adjusted up to 20 seconds maximum in 50 millisecond increments.
- *Zeroing.* Automatic zeroing (nulling of offsets for the sensor and input channel) is done independently on each range to eliminate zero carryovers.
- *Power Sensors.* A wide range of diode and thermocouple power sensors for both coaxial and waveguide applications are available for use with the Model 4240. Frequency Calibration factors traceable to NIST standards are stored in each power sensor's EEPROM and downloaded to the instrument. Data sensor adapters are supplied with the Model 4240, however, the power sensor must be ordered separately.

Diode sensors measure the voltage across a precision resistor, using specially selected diodes. Detection is square law (true RMS) over approximately the lower two-thirds of the sensor's dynamic range, and peak detecting over the upper portion. Because the instrument is calibrated for sine waves over the entire range, measurements at the top one-third of the sensor's dynamic range are valid only for non-modulated signals. In the RMS region, linearity is excellent, and any signal type can be measured. The diode range has been extended into the peak detecting region with the use of real time shaping for the diode curve. When coupled with the high sensitivity of the diode, such shaping allows a dynamic range of 90 dB. Diode sensors are rugged and have an overload headroom of more than 5 dB for continuous signals. The dynamic range in the RMS region can be extended further through use of an external attenuator.

Thermal sensors measure the voltage developed across a dissimilar metal junction caused by the thermal gradient generated by the RF power being measured. Because these sensors are heat detecting, they provide true RMS response over their entire range. Very high peak powers (15 to 30 watts) can be accommodated for very short duty cycles and still provide valid results. The dynamic range is 50 dB. Thermal sensors are not as sensitive as diode sensors.

The data sensor adapter contains non-volatile memory for storage of the calibration data. In addition, calibration data for up to four sensors can be stored in the instrument's non-volatile memory. The user can enter both the linearity and high frequency sensor calibration correction data which are supplied with each sensor. For sensors ordered with the Model 4240, the calibration data is loaded into the data sensor adapter prior to shipment. When the frequency of the RF signal to be measured by one of these sensors is entered, the instrument looks up the appropriate calibration factors, interpolates as necessary, and automatically applies the correction to the measured value. Calibration factors for sensors ordered with the instrument are stored in the plastic pouch attached to the inside of the instrument's top cover.

- *Built-In Precision Calibrator.* A 50 MHz step calibrator, traceable to NIST, enhances measurement accuracy and reliability. The user-selectable automatic calibration routine calibrates most sensors and the instrument in steps over the full dynamic range.

# Boonton 4240 Series RF Power Meter

- *Simple Instrument Setup and Operation.* In the operating mode the functions: Averaging Time, and Frequency menus are selected with a single keystroke. Values for these parameters are displayed and can be adjusted by using the arrow and enter keys. Additional operating parameters can be modified through the menu driven structure accessible via the <Menu> and <Sensor> keys
- *One key press operations.* To provide for ease of use operation of the instrument functions that are used often are performed with a single push of a button. Common operations such as Zeroing the channel, performing a 0 dBm calibration and setting a Reference Level can be done simply by pressing the Zero/Cal and REF Level key respectively.

Zero/Cal – When measuring low level signals it is important to zero the channel prior to measuring the signal. When the Active Channel is measuring levels below approximately -50 dBm, depressing the “Zero/Cal” key will use the measured reading as the zero offset. This allows for fast zeroing of the channel so that the needed measurement can be performed faster.

The user may also perform a 0 dBm calibration by one key stroke of the “Zero/Cal” button. Simply connect the sensor to a 0 dBm source and press the “Zero/Cal” key. The instrument detects that a 0 dBm signal is present and sets a calibration factor accordingly to indicate 0.00 dBm.

The Zero/Cal sub-menu can be displayed by first pressing the Menu key followed by the Zero/Cal key. From there the user chooses the function (Zero, Fixed Cal, Auto Cal) and the channel to perform the calibration on.

REF Level – Often relative measurements are required especially when measuring system gains and losses. One key press of the Ref/Level key makes this job easier and faster to perform. Simply connect the active channel’s sensor to the input signal of the system under test. Press the Ref/Level key and the reference level is set! Next connect the sensor to the system output and read the gain or loss directly from the reference level measurement.

The REF Level sub-menu can be displayed by first pressing the Menu key followed by the REF Level key. From there the user may LOAD or SET the reference level on either channel.

- *Chart Recorder Output.* A 0 to 10 volt dc output, proportional to the measurement values, is available for application to a chart recorder. The Recorder Output is selectable to track either channel 1, channel 2 or the active channel.
- *Flexible Remote Control.* All instrument functions except power on/off can be controlled remotely via the standard GPIB bus interface or RS232 connection. Setup of interface parameters is menu driven; front panel indicators keep the user informed of bus activity. Remote control programming is performed using industry-standard SCPI programming syntax. The 4230 emulation mode is provided for users that prefer back compatibility with legacy Boonton products such as the 4230 series and 4220 line of power meters.
- *Stored Configurations.* For applications in which the same instrument configurations are used repeatedly, up to 10 complete setups can be stored and recalled.

# Boonton 4240 Series RF Power Meter

## 1.4 Accessories

Optional 4240 accessories that can be ordered from Boonton Electronics. A data sensor adapter for each channel installed along with the AC power cord is supplied with the instrument. One or more Boonton 51000 series power sensors are required. The power sensors are not supplied as part of the instrument, but must be ordered separately. Additional available accessories include the following:

- a. Model 95004701A F/F Adapter, 41-2A (for connecting Model 41-2A cables end to end)
- b. Model 95004901A Bulkhead Connector F/F, 41-2A (for connecting Model 41-2A cables end to end)
- c. Model 95401501A Rack Mounting Kit
- d. Model 95109001A Additional Sensor Data Adapters

Table 1-1 Accessories for the 4240 Series

| Selection       | Part Number | Description                                                                          |
|-----------------|-------------|--------------------------------------------------------------------------------------|
| <b>Standard</b> |             |                                                                                      |
|                 | 56810400A   | Line Cord (US)                                                                       |
|                 | 98601300x*  | Manual CD, Boonton Measurement Instruments (CD-ROM)<br>(x* - denotes revision level) |
| <b>Optional</b> |             |                                                                                      |
|                 | 545504000   | Fuse, 0.5A 250V                                                                      |
|                 | 95401501A   | Rack Mounting Kit                                                                    |
|                 | 95403001A   | Rack Mounting Kit (Brackets only)                                                    |
|                 | 95403003A   | Rack Mounting Kit (Brackets with handles)                                            |
|                 | 95105501A   | Type N to K Adaptor (for sensors with K-Connector®)                                  |
|                 | 95109101A   | CW Sensor Combo Cable/Data Adapter – 5 ft (1.27 m)                                   |
|                 | 95109102A   | CW Sensor Combo Cable/Data Adapter – 10 ft (2.54 m)                                  |
|                 | 95109001A   | CW Sensor Data Adapter – with connector for 41-2A cable                              |
|                 | 41-2A       | CW Sensor Cable – 5ft (1.27 m)                                                       |
|                 | 41-2A/10    | CW Sensor Cable – 10ft (2.54 m)                                                      |
|                 | 41-2A/20    | CW Sensor Cable – 20ft (5.05 m)                                                      |
|                 | 41-2A/50    | CW Sensor Cable – 50ft (12.7 m)                                                      |
|                 | 41-2A/100   | CW Sensor Cable – 100ft (25.4 m)                                                     |
|                 | 95004701A   | F/F Adapter, 41-2A (for connecting Model 41-2A cables end to end)                    |
|                 | 95004901A   | Bulkhead Connector F/F, 41-2A (for connecting Model 41-2A cables end to end)         |
|                 | 98406700A   | Instruction Manual 4240 Series, <i>English</i> (Printed w/binder)                    |

### Sensors

For sensor selection, refer to the BOONTON Sensor Manual (985019).

## 1.5 Models, Options and Configurations

- Model 4241. One measurement channel; sensor and calibrator connectors located on the front panel.  
Model 4242. Two measurement channels; sensor and calibrator connectors located on the front panel.  
Opt -01. Rear Panel Channel input(s).  
Opt -02. Rear Panel Calibrator output.  
Opt -30. Warranty option: Extend factory warranty to 3 years

# Boonton 4240 Series RF Power Meter

Option designations are appended to the instrument's base model number. For example, Model 4242-01-02 would be a two-channel instrument with sensor and calibrator connectors all on the rear panel.

Specials. Custom configurations have  $-S/n$  appended to the model number, where  $n$  is a unique number.

## 1.6 Specifications

Performance specifications for the 4240 Series are listed in Table 1-2.

Performance specifications for all Boonton power sensors are found in the *Boonton Sensor Manual*, which may be ordered as Boonton p/n 98501900x\* (x\* - denotes revision level).

**Table 1-2 4240 Series Performance Specifications**  
(Specifications are subject to change without notice)

### SENSOR INPUTS

|                     |                                                                                          |
|---------------------|------------------------------------------------------------------------------------------|
| RF Frequency Range: | 1 MHz to 110 GHz <sup>1</sup>                                                            |
| Power Range:        | -70 to +44 dBm <sup>1</sup>                                                              |
| Power Sensors:      | Accepts sensor data adapter and is compatible with all Boonton diode and thermal sensors |
| Dynamic Range:      | Up to 90 dB with diode sensors; up to 50 dB with thermal sensors                         |
|                     | ( <sup>1</sup> Sensor dependant )                                                        |

### FEATURES

|                             |                                                                                                  |
|-----------------------------|--------------------------------------------------------------------------------------------------|
| Display                     | Menu-driven 20 character x 4 line LCD                                                            |
| Display Units               | MW, kW, W, mW, $\mu$ W, nW, dBW, dBm, dBuW, dBnW, dBr, %                                         |
| Display Resolution          | 0.001 dB or 5 digits (in Watts mode)                                                             |
| Display Offset              | -99.99 dB to +99.99 dB in 0.01 dB steps                                                          |
| Limiting                    | Individual high and low limit thresholds, -99.99 dB to +99.99 dB                                 |
| Peak Power Mode             | Programmable duty cycle from 0.01 to 100.00% in 0.01 steps                                       |
| Ranging                     | Manual (7 ranges) or autoranging                                                                 |
| Filtering                   | Filter times to 20.00 seconds in 0.05 second increments                                          |
| Zeroing                     | Automatic function; calculates, stores, and applies zero corrections to each range               |
| High Frequency Cal Factors: | +3 dB to -3 dB in 0.01 dB steps; cal factors also stored in sensor data adapter.                 |
| Reference Level             | -99.99 dB to +99.99 dB in 0.01 dB steps for dBr measurements may be express in % in linear mode. |



# Boonton 4240 Series RF Power Meter

Table 1-2 4240 Series Performance Specifications (*continued*)  
(Specifications are subject to change without notice)

## UNCERTAINTIES

|                             |                                                                                                                                                                                                                            |
|-----------------------------|----------------------------------------------------------------------------------------------------------------------------------------------------------------------------------------------------------------------------|
| Measurement Accuracy        | Sum of following uncertainties (errors are $\pm$ worst case): instrument uncertainty, noise/signal percentage, power reference uncertainty, sensor shaping, temperature drift, mismatch, and frequency calibration factors |
| Instrument Uncertainty      | $\pm 0.23\%$ ( $\pm 0.01$ dB) at full scale; $\pm 0.46\%$ ( $\pm 0.02$ dB) at 1/10 full scale                                                                                                                              |
| Noise/signal Percentage     | Convert 2 sigma noise listed in the <i>Power Sensor Manual</i> , to percent of the applied power level.                                                                                                                    |
| Power Reference Uncertainty | Refer to Table 1-2 Power Reference: Level Accuracy                                                                                                                                                                         |
| Sensor Shaping              | $\pm 1.0\%$ ( $\pm 0.04$ dB) typical, <i>Power Sensor Manual</i>                                                                                                                                                           |
| Temperature Drift           | Refer to <i>Power Sensor Manual</i>                                                                                                                                                                                        |

## MEASUREMENT SYSTEM

|                        |                                               |
|------------------------|-----------------------------------------------|
| Sensor inputs:         | One or two sensor measurement channels.       |
| Measurement Technique: | 24 bit Sigma-delta A/D converter per channel. |

## CALIBRATION SOURCE

|                                      |                                                                                                                                        |
|--------------------------------------|----------------------------------------------------------------------------------------------------------------------------------------|
| Internal Calibrator                  |                                                                                                                                        |
| Operating Modes:                     | Off, On CW                                                                                                                             |
| Frequency:                           | 50.025 MHz $\pm$ 0.1%                                                                                                                  |
| Level Range:                         | -60 to +20 dBm                                                                                                                         |
| Resolution:                          | 0.1 dB                                                                                                                                 |
| RF Connector:                        | Type N                                                                                                                                 |
| Source VSWR:                         | 1.05 (reflection coefficient = 0.024)                                                                                                  |
| Accuracy, 0C to 20C, NIST traceable: | At 0 dBm: $\pm 0.055$ dB (1.27%)<br>+20 to -39 dBm: $\pm 0.075$ dB (1.74%)<br>-40 to -60 dBm: $\pm 0.105$ dB (2.45%)                   |
| Auto-calibration:                    | The Calibrator is used to automatically generate linearity calibration data for CW power sensors. Can be used to provide test signals. |

# Boonton 4240 Series RF Power Meter

Table 1-2 4240 Series Performance Specifications (*continued*)  
(Specifications are subject to change without notice)

## EXTERNAL INTERFACES

|                 |                                                                                                                                                                                                            |
|-----------------|------------------------------------------------------------------------------------------------------------------------------------------------------------------------------------------------------------|
| Remote Control: | Complies with IEEE-488.1 and SCPI version 1993.                                                                                                                                                            |
| GPIB:           | Implements AH1, SH1, T6, LE0, SR1, RL1, PP0, DC1, DT1, C0, and E1.                                                                                                                                         |
| RS232:          | Type-D connector, 9 pins.                                                                                                                                                                                  |
| Inputs:         | Front or Rear panel sensor connector; rear panel IEEE-488 connector and RS-232 connector.                                                                                                                  |
| Outputs         | Front panel or optional Rear panel CAL OUT connector, 50 MHz, 100 mW max; rear panel recorder BNC connector, 9.09 kilohm impedance, 0 to 10 volts into 1 megohm (may be operated into 1 kilohm for 1V fs). |

## PHYSICAL AND ENVIRONMENTAL CHARACTERISTICS

|                                      |                                                                                 |
|--------------------------------------|---------------------------------------------------------------------------------|
| Case Dimensions:                     | 8.26W x 3.48H x 13.5D inches (21.0 x 8.9 x 34.3 cm), Half-rack width, 2U height |
| Weight:                              | 5 lbs (2.3kg)                                                                   |
| Power Requirements:                  | 90 to 264 VAC, 47 to 63 Hz, (25VA) maximum.                                     |
| Operating Temperature <sup>2</sup> : | 0 to 55 °C                                                                      |
| Storage Temperature <sup>2</sup> :   | -30 to +60 °C                                                                   |
| Humidity <sup>2</sup> :              | 95% maximum, non-condensing                                                     |
| Altitude <sup>2</sup> :              | Operation up to 15,000 feet                                                     |
| Shock <sup>2</sup> :                 | Withstands ±30G, in X, Y, and Z axes                                            |
| Vibration <sup>2</sup> :             | Withstands 2G                                                                   |

(<sup>2</sup> as per MIL-PRF-28800F)

# Boonton 4240 Series RF Power Meter

Table 1-2 4240 Series Performance Specifications (*continued*)  
(Specifications are subject to change without notice)

## OTHER CHARACTERISTICS

|                      |                                                               |
|----------------------|---------------------------------------------------------------|
| Display:             | Dot matrix 80 character LCD module (4 lines by 20 characters) |
| Keyboard:            | 11 Key conductive rubber                                      |
| Processor:           | 32-bit Digital Signal Processor                               |
| Panel setup storage: | Can save and recall 10 complete “user” setups.                |

## REGULATORY CHARACTERISTICS

|               |                                                                                                                                                                                                                                                                                                                                                                                                                                                                                                                                                                                                                                                                                                                                                                                                                |
|---------------|----------------------------------------------------------------------------------------------------------------------------------------------------------------------------------------------------------------------------------------------------------------------------------------------------------------------------------------------------------------------------------------------------------------------------------------------------------------------------------------------------------------------------------------------------------------------------------------------------------------------------------------------------------------------------------------------------------------------------------------------------------------------------------------------------------------|
| CE Mark:      | Full compliance with the following European Union directives and standards:                                                                                                                                                                                                                                                                                                                                                                                                                                                                                                                                                                                                                                                                                                                                    |
| Safety:       | Low Voltage Directive 2006/95/EC<br>IEC 61010 – 1 : 2001 (2 <sup>nd</sup> Edition); EN 61010 – 1 : 2001 (2 <sup>nd</sup> Edition)                                                                                                                                                                                                                                                                                                                                                                                                                                                                                                                                                                                                                                                                              |
| EMC:          | Electromagnetic Compatibility Directive 2004/108/EC<br>IEC 61000-3-2: 2000 Limits for harmonic current emissions<br>IEC 61000-3-3: 2002 Limitation of voltage changes, voltage fluctuations and flicker<br>IEC 61000-4-2: 2001 Electrostatic discharge immunity test<br>IEC 61000-4-3: 2002 Radiated, radio-frequency, electromagnetic field immunity test<br>IEC 61000-4-4: 2004 Electrical fast transient/burst immunity test<br>IEC 61000-4-5: 2001 Surge immunity test<br>IEC 61000-4-6: 2003 Immunity to conducted disturbances, induced by radio frequency fields.<br>IEC 61000-4-11: 2004 Voltage dips, short interruptions and voltage variations immunity test<br>EN 61326-1: 2006 Electrical equipment for measurement, control and laboratory use – EMC requirements - Part 1: General requirements |
| RoHS:         | RoHS Directive 2002/95/EC                                                                                                                                                                                                                                                                                                                                                                                                                                                                                                                                                                                                                                                                                                                                                                                      |
| Construction: | Manufactured to the intent of MIL-T28800E, Type III, Class 5, Style E                                                                                                                                                                                                                                                                                                                                                                                                                                                                                                                                                                                                                                                                                                                                          |

# Boonton 4240 Series RF Power Meter

This page intentionally left blank.

## 2. Installation

This section contains unpacking and repacking instructions, power requirements, connection descriptions and preliminary checkout procedures.

### 2.1 Unpacking & Repacking

The 4240 Series is shipped complete and is ready to use upon receipt. Figure 2-1 shows you the various pieces included in the packaging and the order in which they are loaded into the container. Actual details may vary from the illustration.

#### Note



Save the packing material and container to ship the instrument, if necessary. If the original materials (or suitable substitute) are not available, contact Boonton Electronics to purchase replacements. Store materials in a dry environment. Refer to the Physical and Environmental Specifications in Table 1-2 for further information.

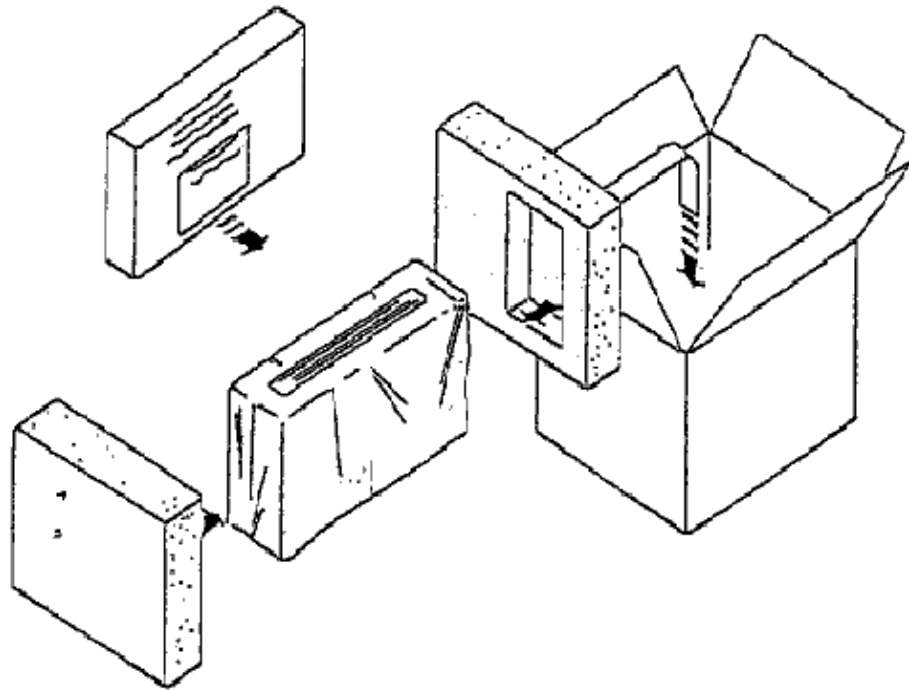

Figure 2-1. Packaging Diagram

# Boonton 4240 Series RF Power Meter

## Table 2-1 4240 Series Packing List

### INSTRUMENT (See also Table 1-1)

4240 Series RF Power Meter  
Line Cord  
Boonton Instruction Manual CD

### SENSOR(S) (packaged separately)

Sensor(s)  
Sensor Cable(s)  
Type N to SMA Adapter (if required)  
BOONTON Sensor Manual CD

For bench-top use, choose a clear, uncluttered area. Ensure that there is at least 2" of clearance at the exhaust vents on the side panels. Pull-down feet are located on the bottom of the instrument. Rack mounting instructions are provided with the optional rack mount kit.

## 2.2 Power Requirements

The 4240 Series is equipped with a switching power supply that provides automatic operation from a 90 to 260 volt, 47 to 63 Hz, single-phase, AC power source. Maximum power consumption is 15W and 25VA. For metric fuse sizes, use the metric fuse kit supplied. Connect the power cord supplied with the instrument to the power receptacle on the rear panel. See Figure 3-2.

### Caution



Before connecting the instrument to the power source, make certain that a 0.5-ampere time delay fuse (type T) is installed in the fuse holder on the rear panel.

Before removing the instrument cover for any reason, position the input module power switch to off (0 = OFF; 1 = ON) and disconnect the power cord.

## 2.3 Connections

### Sensor(s)

Connect the sensor that covers the frequency range of the measurement to the CHANNEL 1 sensor connector on the front (Standard) or rear (Optional) panel, as follows. Connect the sensor to the sensor cable. Connect the sensor cable to the CHANNEL 1 Input, holding the red mark on the cable connector up. For two-channel measurements, use the same procedures to connect the second sensor to the CHANNEL 2 Input.

### Note



If the sensor connector is not a type N, install the appropriate adapter (from the accessories kit) on the calibrator output connector.

# Boonton 4240 Series RF Power Meter

**Recorder** If a recorder is to be used to record measurement data, connect the recorder to the recorder BEC connector on the rear panel. Output impedance is 9.06 kilohms, and the output voltage range is 0 to 10 volts dc.

**Remote** If the instrument is to be operated remotely using the GPIB (IEEE-488) bus, connect the instrument to the bus using the rear panel GPIB connector and appropriate cable. For RS-232 control, the rear panel 9 pin RS-232 connector should be used. In most cases, it will be necessary to configure the interface used via the *Menu > SETUP > IEEE* or *Menu > SETUP > RS232* menus.

## 2.4 Preliminary Check

The following preliminary check verifies that the instrument is operational and has the correct software installed. It should be performed before the instrument is placed into service. To perform the preliminary check, proceed as follows:

1. Connect the AC (mains) power cord to a suitable AC power source; 90 to 264 volts AC, 47 to 63 Hz, with a capacity in excess of 75 W. The power supply will automatically adjust to voltages within this range.
2. Attach the sensor data adapter(s) to the front panel CHANNEL connector(s).
3. Set the POWER switch to the ON (1) position.
4. Verify that "BOONTON ELECTRONICS, 4242 RF Power Meter, REV XXXXXXXX" is momentarily displayed where XXXXXXXX represents the revision code. (Note: Model number 4241 display for single channel instruments.) While the sign-on screen is displayed the phrase " A WIRELESS TELECOM GROUP COMPANY" is scrolled along the second line.

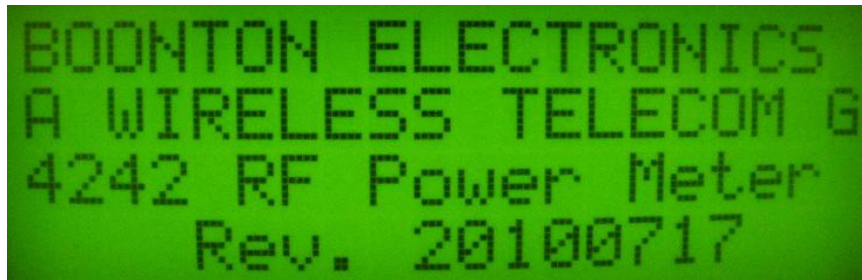

Figure 2-2. Typical Power-On Display

5. Verify that the measurement display showing "CH 1" only for Model 4241 or "CH 1" and "CH 2" for Model 4242. Other data on the display will depend upon previous settings.

## Boonton 4240 Series RF Power Meter

6. Press the <MENU> key and select DIAGNOSTICS with the down arrow key. Press <ENTER>. Verify the following sub-menu:

```
RTN
SELFTEST  <
SWITCHES
RECORDER
```

7. Press <Enter> to execute the self-test. The items tested are as follows:

```
PROCESSOR
SRAM MEMORY
EEPROM
```

Each test will display the OK message if passed. When the test is completed the menu will reappear.

8. Use the <Down Arrow> key to move the "<" cursor to SWITCHES and press <ENTER>. Press each front panel key, avoiding <MENU> until last. Each key press will result in an identifying message; <MENU> will exit the test and return to the MENU.
9. Use the <Down Arrow> key to select RECORDER and press <ENTER>. This test will sequentially send a DC voltage in 1 volt steps to the recorder output BNC connector on the rear panel. The test will continue until <MENU> is pressed. Use a DC voltmeter to verify correct operation.
10. Press <MENU> to return to the measurement display.
11. Press the <Sensor> key and verify that the RF Sensor serial number(s) appear under the channel heading(s). An active channel with no sensor installed will report a table number.
12. Press the <AVG> key and verify that the filter time and number of samples appear for each active channel.
13. With each installed sensor connected to the CAL OUT, press the <Menu> key followed by the <Zero/Cal> key and select ZERO function for the active channel. Verify the ZERO operation completes successfully.
14. Next press the <Menu> key followed by the <Zero/Cal> key and select the FIXED CAL function for the active channel. Verify the CALIBRATE operation completes successfully.
15. Repeat steps 13 and 14 for channel 2 if installed.
16. Connect a GPIB controller to the Model 4240. Verify that the instrument can be addressed to Listen at its IEEE bus address, and set to Remote. The display must show the correct status on the bottom line of the display. For message passing, the line terminators for the controller and the Model 4240 must be compatible for both Listen and Talk. Use <Menu> <SETUP> <IEEE> to set address and terminators for the 4240. Address the Model 4240 to Listen/Remote and send the command "\*IDN?" EOL. Then address the Model 4240 to Talk (controller to listen) and verify that the correct identification string is returned. For example using SCPI emulation the ID string returned would be as follows;  

```
BOONTON ELECTRONICS, 4242, 11002, 20100717
```
17. Connect a dumb terminal or PC serial terminal to the Model 4240. Use a null modem if the terminal is wired as DCE. For message communication to take place, the parameters of the serial connection and message strings must agree between the terminal and the Model 4240. Use <Menu> <SETUP> <RS-232> to set parameters for the 4240. Send the command or "\*IDN?" EOL and verify that the correct identification string is returned.



# 3. Getting Started

This chapter will introduce the user to the 4240 Series. The chapter will identify objects on the front and rear panels, identify display organization, list the initial configuration of the instrument after reset, demonstrate how to calibrate the sensors, and provide practice exercises for front panel operation. For additional information you should see **Chapter 4 "Operation."**

## 3.1 Organization

**Subsection 3.2 Operating Controls, Indicators and Connections** identifies the control features and connections on the front and rear panels.

**Subsection 3.3 Operation** identifies the front panel keys, their functions and the menu structure while describing the various display modes.

## 3.2 Operating Controls, Indicators and Connections

Figures 3-1 and 3-2 illustrate the controls, indicators and connectors on the front and rear panels, respectively, of the standard instrument. Refer to Table 3-1 for a description of each of the illustrated items. Connectors indicated by an asterisk (\*) may be front or rear-mounted, depending on the option selected. The function and operation of all controls, indicators and connectors are the same on the standard and optional models.

# Boonton 4240 Series RF Power Meter

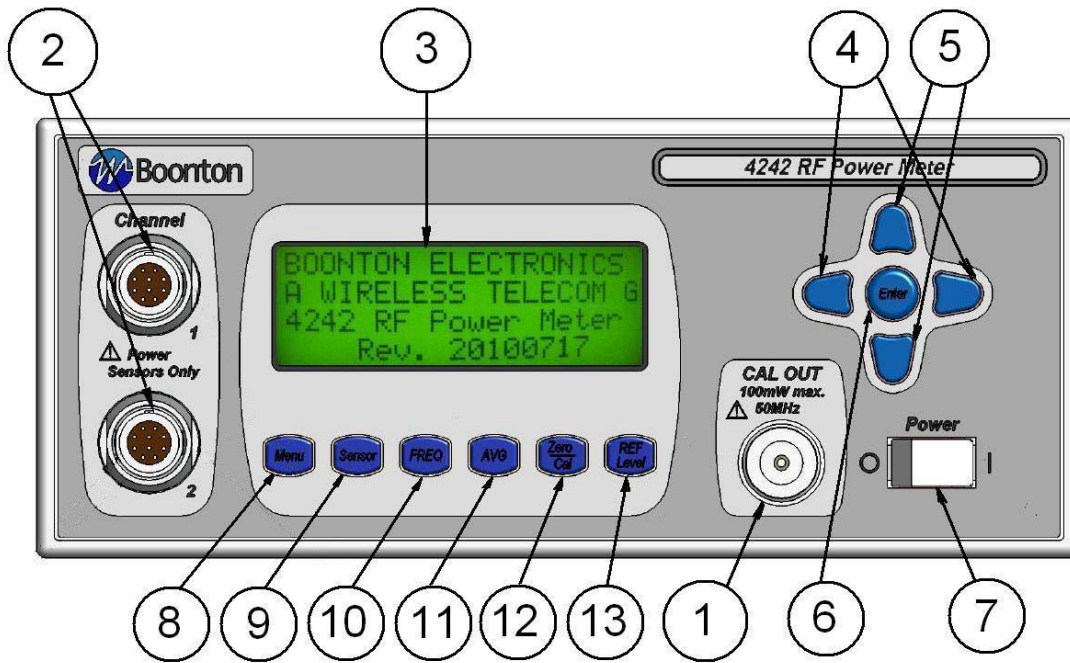

Figure 3-1. Standard 4240 Series RF Power Meter - Front Panel

Table 3-1 Operating Controls, Indicators and Connections

| Reference # | Front | Rear | Nomenclature        | Function                                                                                                                                                                                                                                                                                                                    |
|-------------|-------|------|---------------------|-----------------------------------------------------------------------------------------------------------------------------------------------------------------------------------------------------------------------------------------------------------------------------------------------------------------------------|
| 1           | 1     |      | Internal Calibrator | The output of the built-in 50MHz programmable calibrator is available from a Type-N connector located on the front, or optionally on the rear panel of the instrument. This calibrator is used to automatically calibrate sensor offset and linearity, and can also be used as a general purpose calibration signal source. |
| 2           | 2     |      | Channel Inputs      | One or two Channel inputs are located on the front, or optionally on the rear panel of the instrument. These are 10-pin precision connectors designed to accept only Boonton CW power sensors.                                                                                                                              |
|             |       |      | <b>Caution</b>      | Do not attempt to connect anything other than a Boonton power sensor and sensor data adapter to the Channel inputs! The Channel inputs are not measurement terminals and cannot be used for other than the intended purpose.                                                                                                |
| 3           |       |      | Display Screen      | LCD readout of the measurements and user interface for editing of the instrument's operating parameters.                                                                                                                                                                                                                    |



# Boonton 4240 Series RF Power Meter

Table 3-1 Operating Controls, Indicators and Connections *(continued)*

| Reference # | Front Rear | Nomenclature   | Function                                                                                                                                                                                                                                                                                                                                                                                                                                                                                                                                                                                                                                                                                                                                                                                                                                                                                                                                                                                         |
|-------------|------------|----------------|--------------------------------------------------------------------------------------------------------------------------------------------------------------------------------------------------------------------------------------------------------------------------------------------------------------------------------------------------------------------------------------------------------------------------------------------------------------------------------------------------------------------------------------------------------------------------------------------------------------------------------------------------------------------------------------------------------------------------------------------------------------------------------------------------------------------------------------------------------------------------------------------------------------------------------------------------------------------------------------------------|
| 4           |            | ◀ and ▶ Keys   | In entry mode, pressing ◀ advances the cursor to the left. In the measurement mode of operation pressing the ◀ key sets the Active channel to Linear measurement units (Watts, %). In entry mode, pressing ▶ advances the cursor to the right. In the measurement mode of operation pressing the ▶ key sets the Active channel to Log measurement units (dBm, dBr).                                                                                                                                                                                                                                                                                                                                                                                                                                                                                                                                                                                                                              |
| 5           |            | ▲ and ▼ Keys   | Used for incrementing or decrementing numeric parameters, selecting from lists, or scrolling through multi-line displays. In the measurement mode of operation pressing the ▲ key moves the Active Channel cursor up on the display. For example if the active channel is set to 2, pressing the ▲ key will cause channel 1 to be the active channel. Pressing the ▼ key moves the Active Channel cursor down on the display. If the active channel is set to 1, pressing the ▼ key will cause channel 2 to be the active channel.                                                                                                                                                                                                                                                                                                                                                                                                                                                               |
| 6           |            | Enter Key      | In entry mode, initiates the procedure to change a parameter. In parameter entry mode, terminates the current command and changes the parameter to the last displayed value. In the measurement mode, display the active channels CHANNEL menu.                                                                                                                                                                                                                                                                                                                                                                                                                                                                                                                                                                                                                                                                                                                                                  |
| 7           |            | Power Switch   | Turns the instrument off and on.                                                                                                                                                                                                                                                                                                                                                                                                                                                                                                                                                                                                                                                                                                                                                                                                                                                                                                                                                                 |
| 8           |            | <Menu> Key     | Displays and allows editing of the instrument's operating parameters. Returns instrument to local mode when operating in the bus remote mode. Escapes back to measurement screen from any menu.                                                                                                                                                                                                                                                                                                                                                                                                                                                                                                                                                                                                                                                                                                                                                                                                  |
| 9           |            | <Sensor> Key   | Displays the serial number of the installed sensors and allows for editing of the sensor parameters.                                                                                                                                                                                                                                                                                                                                                                                                                                                                                                                                                                                                                                                                                                                                                                                                                                                                                             |
| 10          |            | <FREQ> Key     | Selects the operating frequency display.                                                                                                                                                                                                                                                                                                                                                                                                                                                                                                                                                                                                                                                                                                                                                                                                                                                                                                                                                         |
| 11          |            | <AVG> Key      | Selects the filter averaging display for the measurement value.                                                                                                                                                                                                                                                                                                                                                                                                                                                                                                                                                                                                                                                                                                                                                                                                                                                                                                                                  |
| 12          |            | <Zero/CAL> Key | <p>One Key Press Operation. When measuring low level signals it is important to zero the channel prior to measuring the signal. When the Active Channel is measuring levels below approximately -50 dBm, depressing the &lt;Zero/Cal&gt; key will use the measured reading as the zero offset. This allows for fast zeroing of the most sensitive range of the channel so that the needed measurement can be performed faster.</p> <p>The user may also perform a 0 dBm Fixed Calibration by one key stroke of the &lt;Zero/Cal&gt; button. Simply connect the sensor to a 0 dBm source and press the &lt;Zero/Cal&gt; key. The instrument detects that a 0 dBm signal is present and sets a calibration factor accordingly to indicate 0.00 dBm.</p> <p>The Zero/Cal menu can be displayed by first pressing the &lt;Menu&gt; key followed by the &lt;Zero/Cal&gt; key. From there the user chooses the function (Zero, Fixed Cal, Auto Cal) and the channel to perform the calibration on.</p> |

# Boonton 4240 Series RF Power Meter

## Table 3-1 Operating Controls, Indicators and Connections *(continued)*

| Reference # | Front Rear | Nomenclature    | Function                                                                                                                                                                                                                                                                                                                                                                                                                                                                                                                                                                                                                                                  |
|-------------|------------|-----------------|-----------------------------------------------------------------------------------------------------------------------------------------------------------------------------------------------------------------------------------------------------------------------------------------------------------------------------------------------------------------------------------------------------------------------------------------------------------------------------------------------------------------------------------------------------------------------------------------------------------------------------------------------------------|
| 13          |            | <REF Level> Key | <p>Often relative measurements are required especially when measuring system gains and losses. One key press of the Ref/Level key makes this easier and faster to perform. Simply connect the active channel's sensor to the input signal of the system under test. Press the Ref/Level key and the reference level is set! Next connect the sensor to the system output and read the gain or loss directly from the reference level measurement.</p> <p>The REF Level menu can be displayed by first pressing the &lt;Menu&gt; key followed by the &lt;REF Level&gt; key. From there the user may LOAD or SET the reference level on either channel.</p> |
| 14          |            | Recorder        | Provides a DC voltage proportional to the measured values for use by an external recorder.                                                                                                                                                                                                                                                                                                                                                                                                                                                                                                                                                                |
| 15          |            | RS232           | 9-pin D-sub connector for connecting the power meter to the remote control Serial Bus. Communication parameters can be configured through the <SETUP <RS232> menu.                                                                                                                                                                                                                                                                                                                                                                                                                                                                                        |
| 16          |            | GPIB            | 24-pin GPIB (IEEE-488) connector for connecting the power meter to the remote control General Purpose Instrument Bus. GPIB parameters can be configured through the <SETUP <IEEE> menu.                                                                                                                                                                                                                                                                                                                                                                                                                                                                   |
| 17          |            | AC Line Input   | A multi-function power input module is used to house the AC line input, main power switch, and safety fuse. The module accepts a standard AC line cord, included with the power meter. The power switch is used to shut off main instrument power. The safety fuse may also be accessed once the line cord is removed. The instrument's power supply accepts 90 to 264VAC, so no line voltage selection switch is necessary.                                                                                                                                                                                                                              |



### Caution

Replace fuse only with specified type and rating:  
0.5 A-T (time delay type), 250VAC

## Boonton 4240 Series RF Power Meter

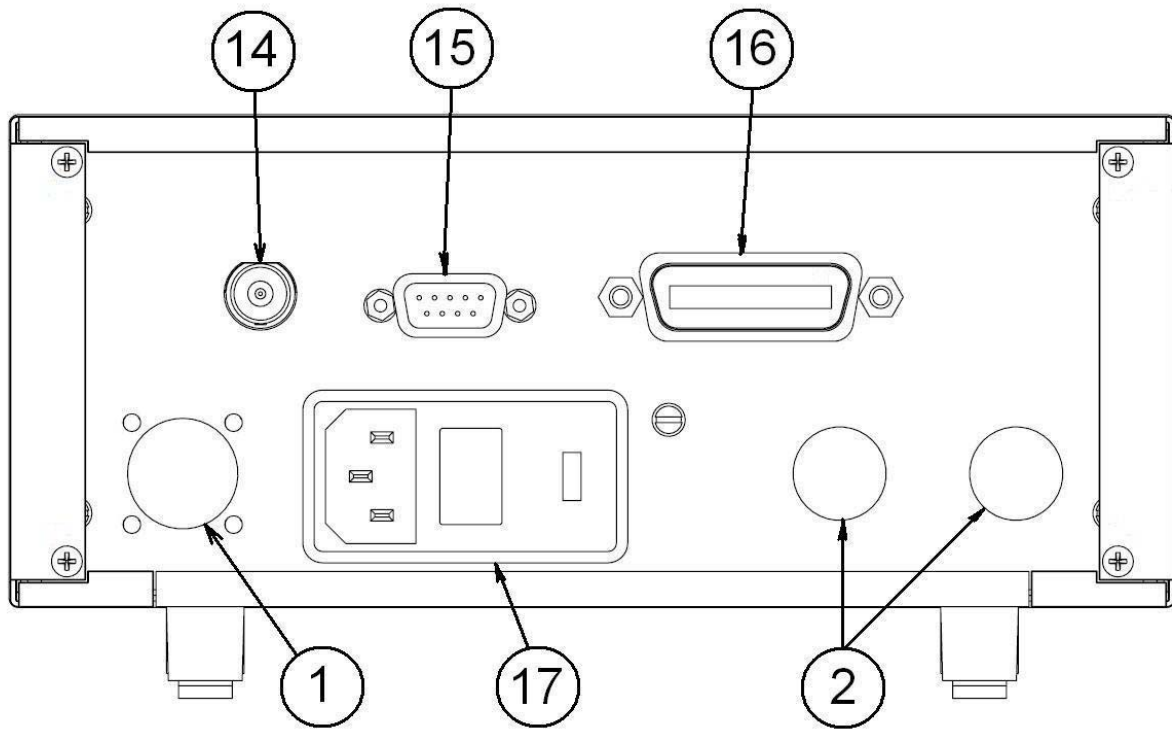

Figure 3-2. 4240 Series - Rear Panel  
(Shown without optional rear panel connectors not installed)

# Boonton 4240 Series RF Power Meter

## 3.3 Operation

The Model 4240 can be configured for operation via the six switches on the front panel;



<Menu>   <Sensor>   <FREQ>   <AVG>   <Zero/Cal><sup>1</sup>   <REF Level><sup>1</sup>  
(<sup>1</sup>single key press operation)

Pressing a key will bring the instrument to the next submenu. A flow chart of the instrument's command structure is shown in figure 3-5. The <Menu> key serves as an ESCAPE key to cancel the current operation from any point and return to the measurement screen.

To change a value, use the arrow keys to position the cursor to the desired parameter. Press the <Enter> key and then use the up/down arrow keys to scroll through the parameter list. When a number is to be entered, use the left/right arrow keys to position the cursor under the number that is to be changed, then use the up/down arrow keys to increment/decrement the number. Holding the up/down arrow key will initiate repeat mode to allow rapid movement through the selection.

Within a submenu, the ^ v indicators are displayed in the upper right portion of the display when the current screen has additional information that can be obtained by scrolling with the up/down arrow keys. Three conditions are possible:

1. ^ Use the up arrow key to scroll the screen upward for additional information.
2. v Use the down arrow key to scroll the screen downward for additional information.
3. ^ v Use the up/down arrow keys to scroll the screen upward/downward for additional information.

Additional features introduced in the 4240 are the 'single key press operation' for the <Zero/Cal> and <REF Level> keys. See section 3.3.5 and 3.3.6 for further details. Also the arrow keys and the <Enter> key have special functions while measurements are displayed.

**Arrow keys group.** Selection of the Active Channel and the channel's measurement units may be accomplished by use of the arrow keys while in the measurement mode of operation.

**Up Arrow key.** Moves the Active Channel cursor up on the display. For example if the active channel is set to 2, pressing the <Up Arrow> key will cause channel 1 to be the active channel.

**Down Arrow key.** Moves the Active Channel cursor down on the display. For example if the active channel is set to 1, pressing the <Down Arrow> key will cause channel 2 to be the active channel.

**Left Arrow key.** Pressing this key sets the Active Channel to Linear measurement units (Watts, %).

**Right Arrow key.** Pressing this key sets the Active Channel to Log measurement units (dBm, dBr).

**Enter key.** When in the measurement mode of operation pressing the <Enter> key causes the instrument to drop down into the CHANNELS menu using the Active Channel as a pointer to the associated channels menu. This provides faster settings of channel parameters such as units, resolution, duty cycle, offset, range, alarm setting and limits.

# Boonton 4240 Series RF Power Meter

## DUAL CHANNEL

|                           |   |   |   |   |   |   |   |   |   |   |   |   |   |   |   |   |   |                           |   |
|---------------------------|---|---|---|---|---|---|---|---|---|---|---|---|---|---|---|---|---|---------------------------|---|
| <sup>A</sup> <sub>C</sub> | M | M | M | M | M | L | ± | D | D | D | D | D | D | U | U | U | U | <sup>P</sup> <sub>K</sub> | Δ |
|                           |   |   |   | ( | B | A | R |   | G | R | A | P | H | ) |   |   |   |                           |   |
| <sup>A</sup> <sub>C</sub> | M | M | M | M | M | L | ± | D | D | D | D | D | D | U | U | U | U | <sup>P</sup> <sub>K</sub> | Δ |
|                           |   |   |   | ( | B | A | R |   | G | R | A | P | H | ) |   |   |   |                           |   |

## SINGLE CHANNEL

|                           |   |   |   |   |   |   |   |   |   |   |   |   |   |   |   |   |   |                           |   |
|---------------------------|---|---|---|---|---|---|---|---|---|---|---|---|---|---|---|---|---|---------------------------|---|
| <sup>A</sup> <sub>C</sub> | M | M | M | M | M | L | ± | D | D | D | D | D | D | U | U | U | U | <sup>P</sup> <sub>K</sub> | Δ |
|                           |   |   |   | ( | B | A | R |   | G | R | A | P | H | ) |   |   |   |                           |   |
|                           |   |   |   |   |   |   |   |   |   |   |   |   |   |   |   |   |   |                           |   |
|                           |   |   |   |   |   |   |   |   |   |   |   |   |   |   |   |   |   |                           |   |

**KEY:** D = 0 through 9 or a decimal point  
 L = ^ , v (alarm mode)  
 M M M M M = CH1, CH2, CH1+2, CH1/2  
 U U U U = V, mV, nW, uW, mW, kW, MW, dBm, dBnW, dBuW, dBnV, dBuV, dBmV, dBV  
<sup>A</sup><sub>C</sub> = Active Channel pointer

Figure 3-3. Measurement Display, Local Mode

|                           |   |   |   |   |   |   |   |   |   |   |   |   |   |   |   |   |   |                           |   |
|---------------------------|---|---|---|---|---|---|---|---|---|---|---|---|---|---|---|---|---|---------------------------|---|
| <sup>A</sup> <sub>C</sub> | M | M | M | M | M | L | ± | D | D | D | D | D | D | U | U | U | U | <sup>P</sup> <sub>K</sub> | Δ |
|                           |   |   |   | ( | B | A | R |   | G | R | A | P | H | ) |   |   |   |                           |   |
| <sup>A</sup> <sub>C</sub> | M | M | M | M | M | L | ± | D | D | D | D | D | D | U | U | U | U | <sup>P</sup> <sub>K</sub> | Δ |
|                           | R | E | M |   |   | L | S | N |   |   | T | L | K |   |   | S | R | Q                         |   |

**KEY:** REM = Remote mode enabled  
 LSN = Listener addressed  
 TLK = Talker addressed  
 SRQ = Service Request activated

Figure 3-4. Measurement Display, Remote Mode

# Boonton 4240 Series RF Power Meter

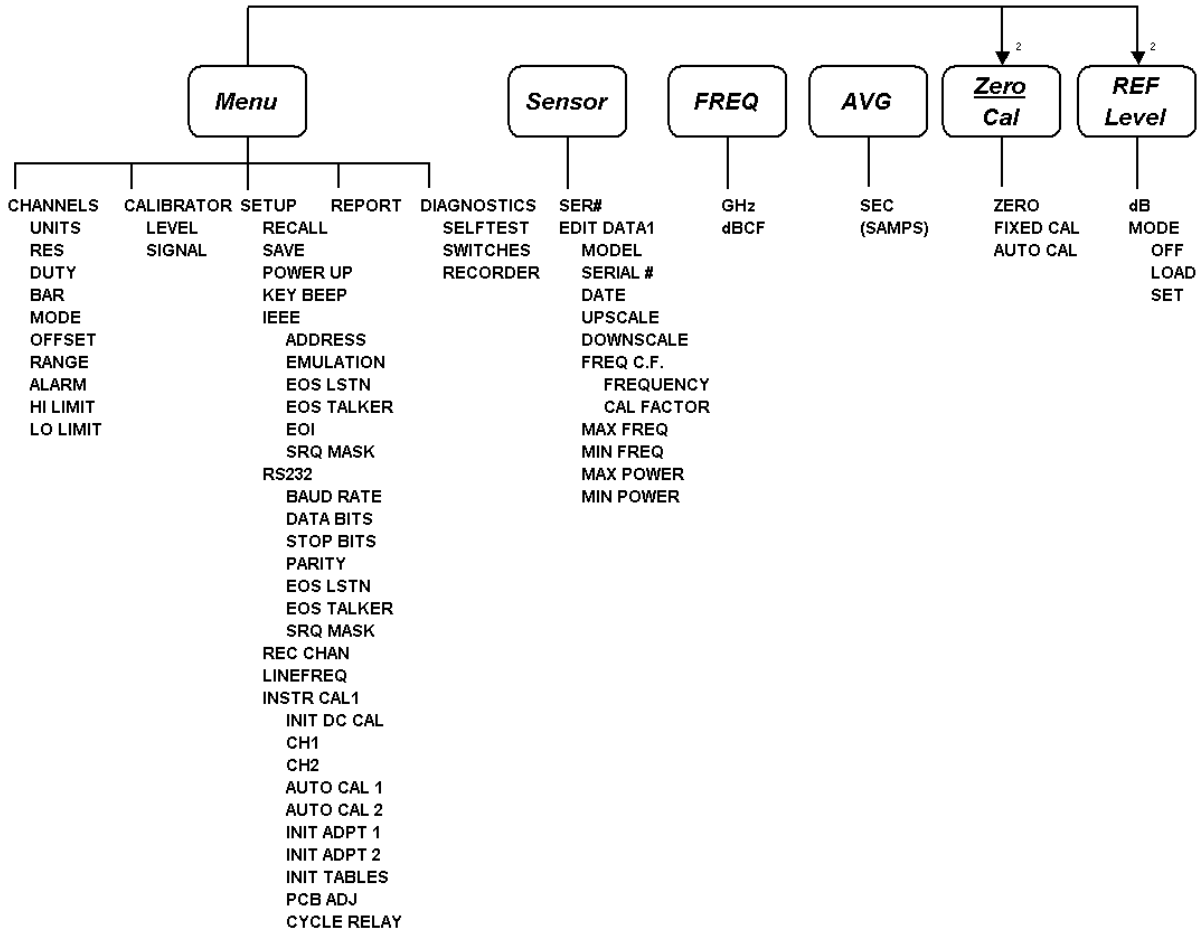

1 This function requires an access code to execute

2 These keys represent action keys in the measurement mode and require pressing the Menu key prior to pressing these keys to access the sub-menu.

Figure 3-5. Model 4240, Command Set

**Last Menu Operation.** In keeping with minimum key strokes to perform a function repeatedly, the control program can remember the last menu the user was at prior to returning to the measurement display. In doing this submenu functions can be quickly selected and parameters changed getting the user back to the measurement display faster.

For example, suppose the user wants to check the sensors linearity using the internal calibrator. The output level needs to be changed repeatedly recording the measurement results at each level. First, the CALIBRATOR LEVEL function is selected. This is accomplished by the following key presses (assuming the Calibrator Signal is already On); <Menu> – <Down Arrow> (to point to CALIBRATOR) – <Enter> –Next press <Enter> to enable the setting of the desired level then press <Enter> to set the calibrator to that level.

Now pressing the <Menu> key will return the instrument to the measurement display. To change the level simply pressing the <Menu> key returns the instrument to the CALIBRATOR LEVEL function.

In this example two key strokes are eliminated which may not seem like a lot but if many levels are needed to be tested, remembering the last menu will save a lot time.

Once in a submenu, the previous menu can always be reached by depressing the <Up Arrow> until RTN or escape to the parent menu using the <Left Arrow> key. If the user exits out to the measurement screen by this method, pressing the <Menu> key will bring up the top level menu.



# Boonton 4240 Series RF Power Meter

## 3.3.1 Menu Key.

The instrument's, CHANNELS, CALIBRATOR, SETUP, REPORT and DIAGNOSTIC functions are accessed when the <Menu> key is pressed. Using the up/down arrow keys, the cursor can be positioned to select from the five submenus.

**Channel Menu.** An example of the display for the Channels menu is shown in Figure 3-7. Although the figure shows eleven lines, the instrument can only display four at a time. Therefore, it will be necessary to use the up/down arrow keys to sequence through the commands. When viewing the commands, the instrument will retain the first line as a header and use the next three lines to scroll through the remaining commands.

Table 3-2 gives a description of the commands available from the Channels menu. The associated parameters, and factory default settings are also given.

**Calibrator Menu.** An example of the display for the Calibrator menu is shown in Figure 3-8. Table 3-3 gives a description of the commands, parameters and default settings of the Calibrator menu.

**Setup Menu.** An example of the display for the Setup menu is shown in Figure 3-9. It will be necessary to use the up/down arrow keys to sequence through the commands since there are more than four lines of information to be displayed. When sequencing through the commands, the instrument will retain the first line as a header and use the next three lines to scroll through the command list.

|   |   |   |   |   |   |   |   |   |   |   |  |  |  |  |  |  |  |  |  |  |
|---|---|---|---|---|---|---|---|---|---|---|--|--|--|--|--|--|--|--|--|--|
| R | T | N |   |   |   |   |   |   |   |   |  |  |  |  |  |  |  |  |  |  |
| C | H | A | N | N | E | L | S |   |   |   |  |  |  |  |  |  |  |  |  |  |
| C | A | L | I | B | R | A | T | O | R |   |  |  |  |  |  |  |  |  |  |  |
| S | E | T | U | P |   |   |   |   |   |   |  |  |  |  |  |  |  |  |  |  |
| R | E | P | O | R | T |   |   |   |   |   |  |  |  |  |  |  |  |  |  |  |
| D | I | A | G | N | O | S | T | I | C | S |  |  |  |  |  |  |  |  |  |  |

Figure 3-6. Main Menu Display

|   |   |   |   |   |   |   |   |  |   |   |   |   |   |   |   |   |   |  |  |  |
|---|---|---|---|---|---|---|---|--|---|---|---|---|---|---|---|---|---|--|--|--|
| R | T | N |   |   |   |   |   |  | C | H | I |   | P | O | W | E | R |  |  |  |
| U | N | I | T | S |   |   |   |  | > | W | A | T | T | S |   |   |   |  |  |  |
| R | E | S |   |   |   |   |   |  | X | X | X | X |   |   |   |   |   |  |  |  |
| D | U | T | Y |   |   |   |   |  | 1 | 0 | 0 | . | 0 | 0 |   |   |   |  |  |  |
| B | A | R |   |   |   |   |   |  | O | N |   |   |   |   |   |   |   |  |  |  |
| M | O | D | E |   |   |   |   |  |   |   |   |   |   |   |   |   |   |  |  |  |
| O | F | F | S | E | T |   |   |  | 0 | . | 0 | 0 |   |   |   |   |   |  |  |  |
| R | A | N | G | E |   |   |   |  | A | U | T | O |   |   |   |   |   |  |  |  |
| A | L | A | R | M |   |   |   |  | O | F | F |   |   |   |   |   |   |  |  |  |
| H | I |   | L | I | M | I | T |  | 9 | 9 | . | 9 | 9 |   |   |   |   |  |  |  |
| L | O |   | L | I | M | I | T |  | - | 9 | 9 | . | 9 | 9 |   |   |   |  |  |  |

Figure 3-7. Channels Menu Display

## Boonton 4240 Series RF Power Meter

Table 3-2 CHANNEL MENU Functions

| Function | Description                                                                                                                                                                                       | Parameters                                         | Defaults |
|----------|---------------------------------------------------------------------------------------------------------------------------------------------------------------------------------------------------|----------------------------------------------------|----------|
| RTN      | Returns the instrument to the previous menu.                                                                                                                                                      | n/a                                                |          |
| UNITS    | Units used for measurement display.                                                                                                                                                               | dBm, WATTS                                         | dBm      |
| RES      | Display resolution                                                                                                                                                                                | X.X, X.XX, X.XXX dBm or/<br>XXX, XXXX, XXXXX Watts | X.XX     |
| DUTY     | Duty cycle for pulse power applications; a value less than 100.00 enables pulse power mode.                                                                                                       | 0.01 to 100.00%                                    | 100.00   |
| BAR      | Enables the bar graph on the measurement display.                                                                                                                                                 | ON, OFF                                            | ON       |
| MODE     | Sets the display mode for channel 2; only available when two channels are installed. The units for sum and ratio modes track the units selected for channel 2.                                    | CH2, CH1+2, CH1/2<br>OFF                           | CH2      |
| OFFSET   | Sets the offset added to the measured value.                                                                                                                                                      | -99.99 to 99.99 dB                                 | 0.00     |
| RANGE    | Selects and holds the instrument's measurement range. If repetitive measurements are to be made over a narrow range of levels, selecting the appropriate instrument range may speed measurements. | AUTO, 0,1,2,3,4,5,6                                | AUTO     |
| ALARM    | Enables alarm mode; the ∨ or ^ symbol is displayed before the channel mode designator on the measurement display to indicate when the upper or lower threshold limit is Exceeded.                 | ON, OFF                                            | OFF      |
| HI LIMIT | Upper threshold limit for the alarm function.                                                                                                                                                     | -99.99 to 99.99                                    | 99.99    |
| LO LIMIT | Lower threshold limit for the alarm function.                                                                                                                                                     | -99.99 to 99.99                                    | -99.99   |

# Boonton 4240 Series RF Power Meter

|   |   |   |   |   |   |  |  |  |  |   |   |   |   |   |   |  |  |  |
|---|---|---|---|---|---|--|--|--|--|---|---|---|---|---|---|--|--|--|
| R | T | N |   |   |   |  |  |  |  |   |   |   |   |   |   |  |  |  |
| L | E | V | E | L |   |  |  |  |  | > | - | 6 | 0 | . | 0 |  |  |  |
| S | I | G | N | A | L |  |  |  |  |   | O | F | F |   |   |  |  |  |
|   |   |   |   |   |   |  |  |  |  |   |   |   |   |   |   |  |  |  |

Figure 3-8. Calibrator Menu Display

**Table 3-3 CALIBRATOR MENU Functions**

| Function | Description                                  | Parameters     | Defaults |
|----------|----------------------------------------------|----------------|----------|
| RTN      | Returns the instrument to the previous menu. | n/a            |          |
| LEVEL    | The calibrator output level in dBm.          | -60.0 to +20.0 | -60.0    |
| SIGNAL   | Sets the calibrator output on or off.        | ON, OFF        | OFF      |

|   |   |   |   |   |   |   |   |   |  |   |   |   |   |   |   |   |   |  |
|---|---|---|---|---|---|---|---|---|--|---|---|---|---|---|---|---|---|--|
| R | T | N |   |   |   |   |   |   |  |   |   |   |   |   |   |   |   |  |
| R | E | C | A | L | L |   |   |   |  | > | 1 |   |   |   |   |   |   |  |
| S | A | V | E |   |   |   |   |   |  |   | 2 |   |   |   |   |   |   |  |
| P | O | W | E | R |   | U | P |   |  |   | D | E | F | A | U | L | T |  |
| K | E | Y |   | B | E | E | P |   |  |   | O | F | F |   |   |   |   |  |
| I | E | E | E |   |   |   |   |   |  |   |   |   |   |   |   |   |   |  |
| R | S | 2 | 3 | 2 |   |   |   |   |  |   |   |   |   |   |   |   |   |  |
| R | E | C |   | C | H | A | N |   |  |   | C | H | 1 |   |   |   |   |  |
| L | I | N | E | F | R | E | Q |   |  |   |   |   |   |   |   |   |   |  |
| I | N | S | T | R |   | C | A | L |  |   |   |   |   |   |   |   |   |  |

Figure 3-9. Setup Menu Display

**Table 3-4 SETUP MENU Functions**

| Function | Description                                                                     | Parameters                           | Defaults |
|----------|---------------------------------------------------------------------------------|--------------------------------------|----------|
| RTN      | Returns the instrument to the previous menu.                                    | n/a                                  |          |
| RECALL   | Recalls one of ten user defined instrument configurations or the factory setup. | DEFAULT, 1-10, SANITIZE <sup>1</sup> | DEFAULT  |

<sup>1</sup> SANITIZE initializes all program locations to DEFAULT settings

# Boonton 4240 Series RF Power Meter

Table 3-4 SETUP MENU Functions (continued)

| Function  | Description                                                                             | Parameters    | Defaults |
|-----------|-----------------------------------------------------------------------------------------|---------------|----------|
| SAVE      | Saves the current instrument configuration to one of ten non-volatile memory locations. | 1-10          | 1        |
| POWER-UP  | Instructs the instrument to power-up to the specified configuration.                    | DEFAULT, 1-10 | DEFAULT  |
| KEY BEEP  | Turns on/off the key beep.                                                              | ON, OFF       | OFF      |
| IEEE      | Brings the instrument to the IEEE menu.                                                 | see table 3-5 | n/a      |
| RS232     | Brings the instrument to the RS-232 menu.                                               | see table 3-6 | n/a      |
| LINEFREQ  | Select line (mains) frequency.                                                          | 50Hz, 60Hz    | n/a      |
| INSTR CAL | Refer to Service Manual.                                                                | n/a           | n/a      |

**IEEE Menu.** The IEEE submenu is used to configure the Model 4240 for communications over the GPIB. An example of the menu is shown in Figure 3-10 and the description of the commands, parameters and factory defaults is given in Table 3-5.

|   |   |   |   |   |   |   |   |   |   |  |   |   |   |   |   |  |  |  |  |
|---|---|---|---|---|---|---|---|---|---|--|---|---|---|---|---|--|--|--|--|
| R | T | N |   |   |   |   |   |   |   |  |   |   |   |   |   |  |  |  |  |
| A | D | D | R | E | S | S |   |   |   |  | > | 1 | 3 |   |   |  |  |  |  |
| E | M | U | L | A | T | I | O | N |   |  |   | S | C | P | I |  |  |  |  |
| E | O | S |   | L | S | T | N |   |   |  |   | C | R | L | F |  |  |  |  |
| E | O | S |   | T | A | L | K | E | R |  |   | C | R | L | F |  |  |  |  |
| E | O | I |   |   |   |   |   |   |   |  |   | O | N |   |   |  |  |  |  |
| S | R | Q |   | M | A | S | K |   |   |  |   | 0 |   |   |   |  |  |  |  |

Figure 3-10. IEEE Menu Display

Table 3-5 IEEE MENU Functions

| Function  | Description                                  | Parameters             | Defaults |
|-----------|----------------------------------------------|------------------------|----------|
| RTN       | Returns the instrument to the previous menu. | n/a                    |          |
| ADDRESS   | GPIB address assigned to the instrument.     | 0 to 30                | n/a      |
| EMULATION | GPIB emulation mode.                         | SCPI, 437B, 438A, 4230 | SCPI     |

## Boonton 4240 Series RF Power Meter

Table 3-5 IEEE MENU Functions *(continued)*

| Function   | Description                                                         | Parameters                                                                                                     | Defaults |
|------------|---------------------------------------------------------------------|----------------------------------------------------------------------------------------------------------------|----------|
| EOS LSTN   | End of string indicator for received messages.                      | LF, CR, CRLF, NONE<br>Where:<br>LF = Line Feed<br>CR = Carriage Return<br>CRLF = Carriage Return and Line Feed | LF       |
| EOS TALKER | End of string character sent with transmitted messages.             | LF, CR, CRLF, NONE                                                                                             | LF       |
| EOI        | Enables/disables the end or identify hardware control line.         | ON, OFF                                                                                                        | OFF      |
| SRQ MASK   | Service request interrupt mask. See Table 4-7 for bit descriptions. | 0 to 255<br>Where:<br>255 enables all interrupts                                                               | 0        |

**RS232 Menu.** The RS232 menu is used to configure the Model 4240 for serial communications over the RS-232 bus. An example of the submenu is shown in Figure 3-11 and an explanation of the commands, parameters and factory defaults is given in Table 3-6.

|   |   |   |   |   |   |   |   |   |   |   |   |   |   |   |   |  |  |  |  |  |
|---|---|---|---|---|---|---|---|---|---|---|---|---|---|---|---|--|--|--|--|--|
| R | T | N |   |   |   |   |   |   |   |   |   |   |   |   |   |  |  |  |  |  |
| B | A | U | D |   | R | A | T | E |   | > | 3 | 8 | 4 | 0 | 0 |  |  |  |  |  |
| D | A | T | A |   | B | I | T | S |   |   | 8 |   |   |   |   |  |  |  |  |  |
| S | T | O | P |   | B | I | T | S |   |   | 1 |   |   |   |   |  |  |  |  |  |
| P | A | R | I | T | Y |   |   |   |   |   | N | O | N | E |   |  |  |  |  |  |
| E | O | S |   | L | S | T | N |   |   |   | L | F |   |   |   |  |  |  |  |  |
| E | O | S |   | T | A | L | K | E | R |   | C | R | L | F |   |  |  |  |  |  |
| S | R | Q |   | M | A | S | K |   |   |   | 0 |   |   |   |   |  |  |  |  |  |

Figure 3-11. RS232 Menu Display

Table 3-6 RS232 MENU Functions

| Function  | Description                                     | Parameters                                                    | Defaults |
|-----------|-------------------------------------------------|---------------------------------------------------------------|----------|
| RTN       | Returns the instrument to the previous menu.    | n/a                                                           |          |
| BAUD RATE | Rate at which data is transferred over the bus. | 300, 600, 1200, 2400, 4800, 9600, 19200, 38400, 57600, 115200 | 38400    |
| DATA BITS | Number of data bits in a message.               | 7, 8                                                          | 8        |
| STOP BITS | Number of stop bits in a message.               | 1, 2                                                          | 1        |

# Boonton 4240 Series RF Power Meter

Table 3-6 RS232 MENU Functions *(continued)*

| Function   | Description                                                                   | Parameters                                                                                                     | Defaults |
|------------|-------------------------------------------------------------------------------|----------------------------------------------------------------------------------------------------------------|----------|
| PARITY     | Parity bit mode in a message.                                                 | ODD, EVEN, NONE                                                                                                | NONE     |
| EOS LSTN   | End of string indicator for received messages.                                | LF, CR, CRLF, NONE<br>Where:<br>LF = Line Feed<br>CR = Carriage Return<br>CRLF = Carriage Return and Line Feed | LF       |
| EOS TALKER | End of string character sent with transmitted messages.                       | LF, CR, CRLF, NONE                                                                                             | CRLF     |
| SRQ MASK   | Service request interrupt mask. See Section 5.5.1 *STB? for bit descriptions. | 0 to 255<br>Where:<br>255 enables all interrupts                                                               | 0        |

**REPORT Display.** The REPORT menu item displays the versions of the firmware and FPGA image installed in the instrument. The SCPI specification compliance version is also displayed in this report. This display is for informational purposes only and does not support any editing of the data. The REPORT display is shown in Figure 3-12.

|   |   |   |   |   |   |   |   |  |  |  |   |   |   |   |   |   |   |   |  |
|---|---|---|---|---|---|---|---|--|--|--|---|---|---|---|---|---|---|---|--|
|   |   |   |   |   |   |   |   |  |  |  | V | E | R | S | I | O | N |   |  |
| F | I | R | M | W | A | R | E |  |  |  | 2 | 0 | 1 | 0 | 0 | 7 | 1 | 1 |  |
| F | P | G | A |   |   |   |   |  |  |  | 1 | . | 1 | 8 |   |   |   |   |  |
| S | C | P | I |   |   |   |   |  |  |  | 1 | 9 | 9 | 0 |   |   |   |   |  |

Figure 3-12. Report Display

**Diagnostics Menu.** The Model 4240 can be directed to perform self-tests from the diagnostics menu. The Diagnostics menu is shown in Figure 3-13 and a description of each command is given in Table 3-7.

|   |   |   |   |   |   |   |   |  |  |  |  |   |  |  |  |  |  |  |  |
|---|---|---|---|---|---|---|---|--|--|--|--|---|--|--|--|--|--|--|--|
| R | T | N |   |   |   |   |   |  |  |  |  |   |  |  |  |  |  |  |  |
| S | E | L | F | T | E | S | T |  |  |  |  | < |  |  |  |  |  |  |  |
| S | W | I | T | C | H | E | S |  |  |  |  |   |  |  |  |  |  |  |  |
| R | E | C | O | R | D | E | R |  |  |  |  |   |  |  |  |  |  |  |  |

Figure 3-13. Diagnostics Display

Table 3-7 DIAGNOSTICS MENU Functions

| Function | Description                                  | Parameters | Defaults |
|----------|----------------------------------------------|------------|----------|
| RTN      | Returns the instrument to the previous menu. | n/a        | n/a      |

# Boonton 4240 Series RF Power Meter

Table 3-7 DIAGNOSTICS MENU Functions *(continued)*

| Function  | Description                                                                                                                                 | Parameters | Defaults |
|-----------|---------------------------------------------------------------------------------------------------------------------------------------------|------------|----------|
| SELF TEST | Instructs the instrument to perform internal diagnostics and the display test.                                                              | n/a        | n/a      |
| SWITCHES  | Interactive test to verify proper operation of the front panel switches.                                                                    | n/a        | n/a      |
| RECORDER  | The recorder output DAC is exercised through its full range from 0 to 10 V.D.C. in 1V steps continuously until the <Menu> key is depressed. | n/a        | n/a      |

### 3.3.2 Sensor Key.

Pressing the <Sensor> key brings the instrument to the Sensor menu and facilitates viewing and editing of the power sensor's parameters. An access code is required to enter the editing mode (refer to Figure 3-15). A sample display of the Sensor menu is shown in Figure 3-14.

The instrument is capable of using sensor calibration data from either the sensor data adapters or from any one of four internal tables. The sensor calibration data contained within the sensor data adapter is only accessible to the installed channel. For example, Channel 1 can use the sensor calibration data from any of the internal tables or the sensor data adapter 1. Similarly, Channel 2 can use the sensor calibration data from any of the internal tables or the sensor data adapter 2.

Referring to Figure 3-14, the cursor can be positioned to three fields. The two fields below the 'CH1' and 'CH2' indicate the serial number of the sensor whose calibration data is selected for channels 1 and 2 respectively. The instrument uses this data for the linearity and high frequency correction data and automatically applies the correction to the measured value.

|   |   |   |   |   |   |   |   |   |   |   |   |   |   |   |   |   |   |  |
|---|---|---|---|---|---|---|---|---|---|---|---|---|---|---|---|---|---|--|
|   |   |   |   |   |   | C | H | 1 |   |   |   |   | C | H | 2 |   |   |  |
| S | E | R | # | > | 2 | 9 | 3 | 9 | 1 |   |   |   | 3 | 3 | 3 | 7 | 2 |  |
|   |   |   |   |   |   |   |   |   |   |   |   |   |   |   |   |   |   |  |
| E | D | I | T |   | D | A | T | A |   | 2 | 9 | 3 | 9 | 1 |   |   |   |  |

Figure 3-14. Sensor Display Menu

To change the current selection for channel 1, use the arrow keys to move to the SER# command line and position the cursor below the 'CH1' field. Press the <Enter> key and use the up/down arrow keys to scroll through the parameter list. The parameter list typically consists of serial numbers for each power sensor. Scroll through the list until the desired serial number is displayed and press <Enter> to accept. Move the cursor below the 'CH2' field and follow the same procedure used to change the table for channel 2.

The instrument detects the presence of the sensor data adapter and automatically down-loads the sensor calibration data. This occurs when the power to the unit is first applied or after plugging the sensor data adapter into the instrument. The power sensor and corresponding sensor data adapter have matching serial numbers for maintaining them as a matched pair.

### EDIT DATA ACCESS CODE

# Boonton 4240 Series RF Power Meter

The access code to enter the Edit Data menu is as follows:

Press the front panel switches in the following order:

<FREQ> <AVG> <AVG> <FREQ> <Sensor> <Enter>

Figure 3-15. Access Code

|   |   |   |   |   |   |   |   |   |  |  |   |   |   |   |   |   |   |   |   |
|---|---|---|---|---|---|---|---|---|--|--|---|---|---|---|---|---|---|---|---|
| R | T | N |   |   |   |   |   |   |  |  |   |   |   |   |   |   |   |   |   |
| M | O | D | E | L |   |   |   |   |  |  | > | 5 | 1 | 0 | 7 | 5 |   |   |   |
| S | E | R | I | A | L |   |   | # |  |  |   | 2 | 9 | 3 | 9 | 1 |   |   |   |
| D | A | T | E |   |   |   |   |   |  |  |   | 0 | 8 |   | 2 | 3 |   | 1 | 0 |
| U | P | S | C | A | L | E |   |   |  |  |   | 0 | : | 5 | 0 | 0 | 0 |   |   |
| D | O | W | N | S | C | A | L | E |  |  |   | 0 | : | 0 | 0 | 0 | 0 |   |   |
| F | R | E | Q |   | C | . | F | . |  |  |   |   |   |   |   |   |   |   |   |
| M | A | X |   | F | R | E | Q |   |  |  |   | 1 | 8 | . | 0 | 0 |   |   |   |
| M | I | N |   | F | R | E | Q |   |  |  |   | 0 | . | 0 | 0 |   |   |   |   |
| M | A | X |   | P | O | W | E | R |  |  |   | 2 | 3 | . | 0 | 0 |   |   |   |
| M | I | N |   | P | O | W | E | R |  |  |   | - | 7 | 5 | . | 0 | 0 |   |   |

Figure 3-16. Sensor Edit Data Menu Display

The parameter list will show TBLn (where n = 1, 2, 3, 4) when a serial number has not been entered for the corresponding internal table. For example, TBL3 will be displayed if the serial number has not been previously entered for internal table 3. In addition, the parameter list will show ADPTn (where n = 1, 2) if a serial number has not been entered for the table contained within the sensor data adapter. For example, ADPT2 is displayed when the serial number has not been previously entered for sensor data adapter 2.

To edit the sensor calibration data, move the cursor to the EDIT DATA function and press <Enter>. Scroll through the power sensor serial numbers until the desired selection is displayed. Press <Enter> to proceed. Enter the access code to edit or depress the <Menu> key to escape. (See Figure 3-15.)

**Sensor Edit Data Menu.** An example of the Edit Data menu is shown in Figure 3-16. Table 3-8 contains a description of the commands and associated parameters.

Table 3-8 Sensor Edit Data Menu Functions

| Function | Description                   | Parameters | Defaults |
|----------|-------------------------------|------------|----------|
| RTN      | Returns the instrument to the | n/a        | n/a      |
| MODEL    | Power sensor model number     | 0 to 99999 | 0        |
| SER #    | Power sensor serial number    | 0 to 99999 | 0        |

Table 3-8 Sensor Edit Data Menu Functions (continued)



## Boonton 4240 Series RF Power Meter

| Function  | Description                                          | Parameters                                                            | Defaults |
|-----------|------------------------------------------------------|-----------------------------------------------------------------------|----------|
| DATE      | Calibration date                                     | MM/DD/YY<br>Where:<br>MM = 01 to 12<br>DD = 01 to 31<br>YY = 00 to 99 | 01/01/01 |
| UPSCALE   | Upscale linearity factors                            | Range : Factor<br>[0 to 6] : [0 to 9999]                              | 5000     |
| DOWNSCALE | Downscale linearity factors                          | Range : Factor<br>[0 to 6] : [-999 to 999]                            | 0        |
| FREQ C.F. | Brings the instrument to the calibration factor menu | n/a                                                                   | n/a      |
| MAX FREQ  | Power sensor's maximum frequency                     | 0, 100.00 GHz                                                         | 18       |
| MIN FREQ  | Power sensor's minimum frequency                     | 0, 100.00 GHz                                                         | 0.03     |
| MAX POWER | Power sensor's maximum                               | [-99.99, 99.99] dBm                                                   | 20       |
| MIN POWER | Power sensor's minimum power input                   | [-99.99, 99.99] dBm                                                   | -75      |

**Linearity Factors.** Seven upscale and downscale linearity factors are assigned to each power sensor. These values can be viewed or edited by moving the cursor to the UPSCALE or DOWNSCALE command and pressing the <Enter> key. The instrument will sequence through the linearity factors by pressing the up/down arrow keys. If a value is to be edited, scroll to the desired linearity factor, use the right arrow key to move the cursor to the first digit in value field and then use the up/down arrow keys to increment/decrement the number. Set the remaining digits in the same manner. If another value needs to be changed, move the cursor back to the range field and use the up/down arrow keys to display the next value to be modified. Press the <Enter> key when all of the changes have been entered.

**FREQUENCY Calibration Factors.** Up to 60 sensor frequency calibration factors can be entered for each power sensor. Position the cursor to the FREQ C.F. command. Press the <Enter> key to advance to the Cal Factor menu. A sample of the display is shown in Figure 3-17 and an explanation of the commands is shown in Table 3-9.

|  |   |   |   |   |   |   |   |   |   |   |  |  |  |   |   |   |   |   |   |
|--|---|---|---|---|---|---|---|---|---|---|--|--|--|---|---|---|---|---|---|
|  | R | T | N |   |   | F | R | E | Q |   |  |  |  | C | A | L |   |   |   |
|  | 0 |   |   | > | 0 | 0 | 0 | . | 0 | 5 |  |  |  | + | 0 | 0 | . | 0 | 0 |
|  | 1 |   |   |   | 0 | 0 | 1 | . | 0 | 0 |  |  |  | - | 0 | 0 | . | 0 | 3 |
|  | 2 |   |   |   | 0 | 0 | 2 | . | 0 | 0 |  |  |  | - | 0 | 0 | . | 0 | 6 |

Figure 3-17. Frequency Cal Factor Menu Display

# Boonton 4240 Series RF Power Meter

Table 3-9 FREQ Menu Functions

| Function | Description                       | Parameters         | Defaults |
|----------|-----------------------------------|--------------------|----------|
| FREQ     | Frequency                         | 0.01 to 100.00 GHz | 0.05     |
| CAL      | High frequency calibration factor | -3.00 to 3.00 dB   | 0.00     |

The up/down arrow keys are used to scroll through the calibration factor table. Use the arrow keys to move to the desired field and press the <Enter> key to change a value. The up/down arrow keys increment/decrement the value and the left/right arrows keys select the digits. Press the <Enter> key when the desired value is displayed. Move the cursor to the RTN field or depress the <Menu> key to return to the Sensor menu.

The instrument scans the sensor calibration table for a value that matches the operating frequency. Linear interpolation is used if the operating frequency is between two of the table entries. To ensure proper operation, the calibration table must be entered in ascending order and terminated in the last table entry with a zero (0) value for both the FREQ and CAL FACTOR. In addition, new calibration values should be entered while adhering to the chronological order of the table. For example, to add the -0.01 dB calibration factor at 3.5 GHz to the example shown in Figure 3-18, the calibration factors for items four through six are re-entered.

| Factor # | Frequency (GHz) | Cal Factor (dB) |
|----------|-----------------|-----------------|
| 0        | 1               | 0.00            |
| 1        | 2               | 0.08            |
| 2        | 3               | -0.02           |
| 3        | 4               | -0.15           |
| 4        | 5               | -0.08           |
| 5        | 6               | -0.08           |

| Factor # | Frequency (GHz) | Cal Factor (dB) |
|----------|-----------------|-----------------|
| 0        | 1               | 0.00            |
| 1        | 2               | 0.08            |
| 2        | 3               | -0.02           |
| 3        | 3.5             | -0.01           |
| 4        | 4               | -0.15           |
| 5        | 5               | -0.08           |
| 6        | 6               | -0.08           |

Figure 3-18. Calibration Data Example

**Save.** Exiting the EDIT DATA menu displays the confirmation menu as shown in Figure 3-19. Move the cursor to YES to save the edited parameters or NO to leave the data unchanged.

|  |   |   |   |   |   |   |   |   |   |   |   |   |   |   |   |   |   |  |  |  |
|--|---|---|---|---|---|---|---|---|---|---|---|---|---|---|---|---|---|--|--|--|
|  |   |   |   |   |   |   |   |   |   |   |   |   |   |   |   |   |   |  |  |  |
|  | S | T | O | R | E |   | S | E | N | S | O | R |   | D | A | T | A |  |  |  |
|  |   |   | A | R | E |   | Y | O | U |   | S | U | R | E | ? |   |   |  |  |  |
|  |   |   |   |   | Y | E | S |   |   | > | N | O |   |   |   |   |   |  |  |  |

Figure 3-19. Save Display

# Boonton 4240 Series RF Power Meter

## 3.3.3 FREQ Key.

The frequency of the signal being measured must be entered in order to use the stored high frequency calibration factors. The instrument will then compute, display and apply the required correction factor to subsequent measurements.

The operating frequency may be set by first pressing the <FREQ> key. The instrument will advance to the Frequency menu as shown in Figure 3-20. The frequency for Channel 1 is entered by positioning the cursor to the value field under the CH1 heading and pressing the <Enter> key. A value between 0.01 GHz and 100 GHz can be entered. The power on default is 0.05 GHz. Once the frequency is entered, the corresponding Cal Factor is displayed in dB beneath the frequency.

|   |   |   |   |   |   |   |   |   |   |   |  |  |   |   |   |   |   |   |
|---|---|---|---|---|---|---|---|---|---|---|--|--|---|---|---|---|---|---|
| F | R | E | Q | U | E | N | C | Y |   |   |  |  |   |   |   |   |   |   |
|   |   |   |   |   | C | H | 1 |   |   |   |  |  | C | H | 2 |   |   |   |
| G | H | z |   | > | 0 | 1 | 8 | . | 0 | 0 |  |  | 0 | 0 | 2 | . | 5 | 0 |
| d | B | C | F |   | 0 | 0 | 0 | . | 1 | 0 |  |  | - | 0 | 0 | . | 0 | 2 |

Figure 3-20. Frequency Display

## 3.3.4 AVG Key.

The averaging time may be adjusted to optimize measurement speed and display stability. Averaging time, in seconds, can be adjusted in 0.05 increments to a maximum of 20.00 seconds. The length of the filter in number of samples is shown on the display.

To adjust the averaging time, press the <AVG> key and the instrument will display the screen as shown in Figure 3-21. Position the cursor under the desired channel heading and press the <Enter> key. Use the arrow keys to set the desired value and then press <Enter> to accept. Entering 00.00 selects the auto filtering Mode. This menu can be accessed to show the filter setting in the auto mode.

|   |   |   |   |   |   |   |   |   |   |  |  |  |   |   |   |   |   |
|---|---|---|---|---|---|---|---|---|---|--|--|--|---|---|---|---|---|
| T | I | M | E |   |   |   |   |   |   |  |  |  |   |   |   |   |   |
|   |   |   |   |   | C | H | 1 |   |   |  |  |  | C | H | 2 |   |   |
| S | E | C |   | > | 1 | 0 | . | 5 | 0 |  |  |  | 0 | 0 | . | 0 | 8 |
| S | A | M | P | S |   |   | 2 | 1 | 0 |  |  |  |   |   | 1 | 6 |   |

Figure 3-21. Averaging Time Display

## 3.3.5 Zero/Cal Key (single key press operation).

Zeroing should be performed when the unit is first warmed-up, a sensor has been changed or the instrument has drifted a significant amount with respect to the signal level being measured. For large signals (measurements taken on range 4, 5, or 6), this may be done once every several hours. For small signals, (measurements taken on range 0, 1, 2, or 3), zeroing should be done before each measurement for optimum results. When zeroing is performed, the instrument calculates and stores zero corrections for each range, and applies the corrections to subsequent measurements.

Assigning the <Zero/Cal> key as a single key press operation allows for a fast zeroing of the lowest hardware range to avoid the longer zeroing process. When the Active Channel is measuring levels below approximately -50 dBm, and if the measurement is settled, that is, if the filter is full, pressing the <Zero/Cal> key will take the displayed measurement as the zero reference. This allows for faster and more accurate measurements of low level signals. If the measurement is not settled the complete zeroing process of all ranges is performed.

# Boonton 4240 Series RF Power Meter

The user may also perform a 0 dBm calibration by one key stroke of the Zero/Cal key. Simply connect the sensor to a 0 dBm source (either by setting the internal 50MHz calibrator to 0 dBm or connecting to an external 0 dBm source) and press the <Zero/Cal> key. The instrument detects that a 0 dBm signal is present and sets a calibration factor accordingly to indicate 0.00 dBm.

The Zero/Cal menu is displayed by first pressing the <Menu> key followed by the <Zero/Cal> key. From there the user chooses the function (Zero, Fixed Cal, Auto Cal) and the channel to perform the calibration on. The Zero/Cal menu invokes three commands as shown in Figure 3-22.

|  |   |   |   |   |   |   |   |   |   |  |  |   |   |   |  |   |   |   |  |  |
|--|---|---|---|---|---|---|---|---|---|--|--|---|---|---|--|---|---|---|--|--|
|  |   |   |   |   |   |   |   |   |   |  |  | C | H | 1 |  | C | H | 2 |  |  |
|  |   |   |   |   |   | Z | E | R | O |  |  | < |   |   |  |   |   |   |  |  |
|  | F | I | X | E | D |   | C | A | L |  |  |   |   |   |  |   |   |   |  |  |
|  |   | A | U | T | O |   | C | A | L |  |  |   |   |   |  |   |   |   |  |  |

Figure 3-22. Zero and Calibration Display

**ZERO** – performs zeroing of all hardware ranges of the selected channel.

**FIXED CAL** – the internal 50MHz calibrator is set to 0 dBm and a calibration is performed at that point. Fixed Cal may be performed on any 0 dBm source other than the internal calibrator.

The built-in 50 MHz calibrator provides a convenient means for calibrating the instrument. Calibration can be performed any time to assure accuracy.

**AUTO CAL** – improved sensor shaping can be realized by performing a step calibration using the 50 MHz Step Calibrator. To perform an AutoCal, connect the sensor to be calibrated to the desired measurement channel and to the front panel CAL OUT connector. Press the <Menu> key followed by the <Zero/Cal> key. The Zero/Cal menu will be displayed. Navigate the cursor to the AUTO CAL line and select the channel to have the auto cal performed on. Press the <Enter> key to begin the AUTO CAL process. The instrument will return to the measurement window upon completion of the calibration.

### 3.3.6 REL Level Key (single key press operation).

Often relative measurements are required especially when measuring system gains and losses. One key press of the <Ref/Level> key makes this job easier and faster to perform. Simply connect the active channel’s sensor to the input signal of the system under test. Press the <Ref/Level> key and the reference level is set! Next connect the sensor to the system output and read the gain or loss directly from the reference level measurement.

The REF Level menu is displayed by first pressing the <Menu> key followed by the <REF Level> key. From there the user may SET (entering a value ) or LOAD (use the current channel measurement ) the reference level on either channel.

Press the <REF Level> key to enter a value or to use the current channel measurement for the reference level. The measurement units will automatically change to dBr for logarithmic units or % for linear units for subsequent measurements. An example of the instrument's display is shown in Figure 3-23.

|   |   |   |   |   |   |   |   |   |   |   |   |   |   |   |   |   |   |  |  |
|---|---|---|---|---|---|---|---|---|---|---|---|---|---|---|---|---|---|--|--|
| R | E | F | E | R | E | N | C | E |   | L | E | V | E | L |   |   |   |  |  |
|   |   |   |   |   | C | H | 1 |   |   |   |   | C | H | 2 |   |   |   |  |  |
| d | B |   |   | > | + | 0 | 0 | . | 0 | 0 |   | + | 2 | 5 | . | 0 | 0 |  |  |
| M | O | D | E |   | L | O | A | D |   |   |   | S | E | T |   |   |   |  |  |

Figure 3-23. Zero and Calibration Display

# Boonton 4240 Series RF Power Meter

Table 3-10 Reference Level Menu Functions

| Function | Description                                                                                                                                                                                                  | Parameters          | Defaults |
|----------|--------------------------------------------------------------------------------------------------------------------------------------------------------------------------------------------------------------|---------------------|----------|
| dBm      | Reference level value in Preset mode.                                                                                                                                                                        | -99.99 to 99.99 dBm | 0        |
| MODE     | Reference level mode. "LOAD" makes the current channel measurement as the reference level. The Set mode is used to select the entered reference level. The Off mode disables the reference level adjustment. | LOAD, SET, OFF      | OFF      |

To set a reference level, depress the <REF Level> key to display the REFERENCE LEVEL menu. Move the cursor to the reference value for the appropriate channel. (Channel 1 is default.) Depress the <Enter> key to initiate the editing process. Use the arrow keys to edit the reference value in dBm. Once the desired value has been selected, depress the <Enter> key to leave the editing function. To use this value as the reference, depress the <Down> arrow key to MODE, depress the <Enter> key for mode selection and using the <Up> or <Down> arrow keys, select SET. Depressing the <Enter> key will place the appropriate channel to the "dBr" mode of operation using the set value as the reference.

The instrument can also load the current measured value as the reference level. To do this, depress the <REF Level> key to display the REFERENCE LEVEL sub-menu. Navigate the cursor using the arrow keys to the MODE selection of the desired channel. Depress the <Enter> key for mode selection and using the <Up> or <Down> arrow keys, select LOAD. Depressing the <Enter> key will place the appropriate channel to the dBr mode of operation using the measured value as the reference level.

## Boonton 4240 Series RF Power Meter

This page intentionally left blank.

## 4. Operation

This section provides detailed background information on various aspects of operation of the Model 4240. It is assumed that the reader is familiar with the basic operating procedures covered in Section 3. This section covers the following topics: Sensor calibration, Zeroing, Filtering, Noise, Dynamic range, Measurement time, High frequency accuracy, Chart recorder operation and Waveform sensitivity.

### 4.1 Sensor Calibration

**General.** Two types of calibration are associated with the Model 4240 - instrument calibration and sensor calibration. The instrument (less sensors) must be calibrated using a stable and accurate DC source, such as the Boonton Model 2510, to ensure interchangeability of sensors. Instrument calibration procedures are covered in the Model 4240 Service Manual. Sensor calibration data is of two types: linearity and high frequency calibration factors. Sensor calibration data for up to four sensors can be stored in nonvolatile EEPROM plus each sensor data adapter contains the data matched to the corresponding power sensor.

**14-Point Linearity Data.** Linearity data, also referred to as AC reference frequency linearity data, is supplied with the sensor and can be manually entered into the non-volatile Tables or Adapters. For sensors ordered with the instrument, linearity data is stored in the sensor data adapter before the instrument is shipped.

At the reference frequency (50 MHz, or 40, 60, or 94 GHz), each sensor has two gain factors for each range: upscale and downscale points. Refer to Figure 4-1. The upscale points are in the range of 4000-7000, which is a gain correction factor. Upscale points are calibrated at the factory at about 70% of full scale. The downscale number is an offset correction at about 25% of full scale. Thus, for a diode sensor (7 ranges), there are 14 points; for thermal sensors there are eight points. Ranges 0 and 1 share the same data points.

**AutoCal.** Initiates a multi-point sensor gain calibration of the selected sensor with the internal 50MHz step calibrator. This procedure calibrates the sensor's linearity at a number of points across its entire dynamic range. A sensor must be connected to the channel input.

**High Frequency Calibration Points.** In addition to linearity data, there are high frequency calibration points. Calibration points covering the entire sensor frequency range are supplied with each sensor. Below 1 GHz, the sensor response is flat, and frequency calibration points need not be entered.

The Model 4240 provides space for up to 60 points for each sensor table. Frequency calibration points need not be in equal frequency increments; however, the entry of data must be done in ascending order of frequency. For both diode and thermal sensors, a calibration factor of 0 dB is implied at 0.00 GHz so that the instrument may be operated below the first data point.

### 4.2 Zeroing

The automatic zeroing routine of the instrument takes measurements on the lowest five ranges and applies these as correction factors on subsequent measurements. Offsets in the sensor and input amplifiers are linearly corrected in the internal software. Offsets on the highest ranges are below 0.02% of full scale, and do not need correction.

Input power to the sensor must be removed before the zeroing function is executed or an error message will be displayed. The instrument will perform zeroing, however, if the signal is less than full scale on range 0. This feature provides a great deal of offset capability for temperature effects without rezeroing the input amplifier hardware.

For full accuracy at low signal levels, power must be removed from the sensor several seconds before zeroing to allow the sensor to settle. This is especially true if a large signal had been applied to the sensor in the previous 20 seconds or so because of the dielectric absorption of the capacitors in diode sensors, and because of thermal retention in thermal sensors. The error resulting from different input conditions can be determined from Figure 4-2 or 4-3, as applicable. The curves in

# Boonton 4240 Series RF Power Meter

these figures show the decay of measured power after a large signal has been applied. The typical error that can be expected by zeroing too quickly after application of a large signal is equal to the offset power at the time of zeroing.

The Model 4240 initiates zeroing when the ZERO command is invoked. The user must delay zeroing according to system requirements when the sensors are used over a wide dynamic range. For example, if it is determined from the application that five seconds are required from power off to the zeroing operation, then the user should wait five seconds after removing power from the sensor before executing the zero command.

The zeroing time on each range has been optimized for speed and accuracy. Total zeroing time is approximately 20 seconds.

Zeroing should be done when the instrument is turned on, the sensor has been changed, or the instrument has drifted a significant amount with respect to the signal being measured. For large signals (range 4, 5, or 6), this may be once every several hours, if at all. For very small signals (range 0, 1, 2, or 3), for optimum results, zeroing be done immediately before each measurement.

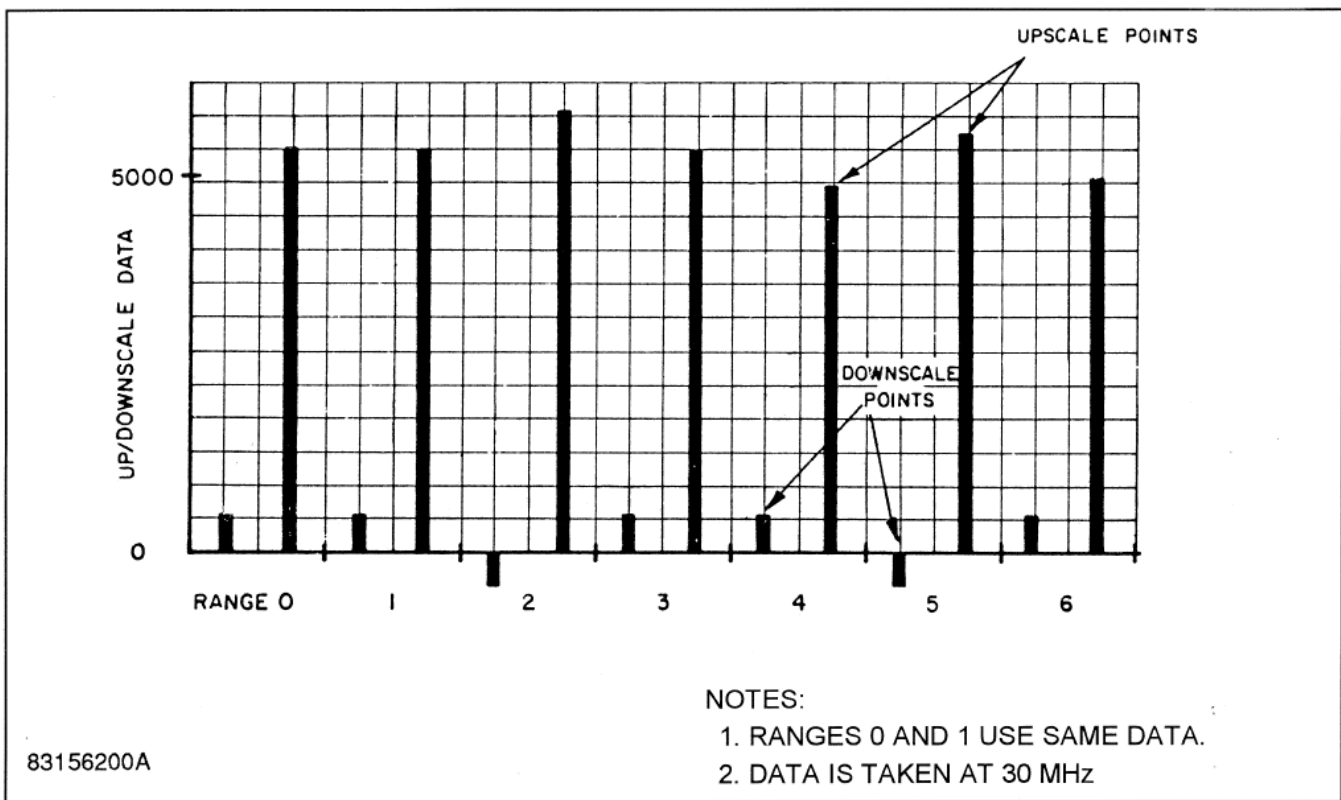

Figure 4-1. 14-Point Sensor Calibration



# Boonton 4240 Series RF Power Meter

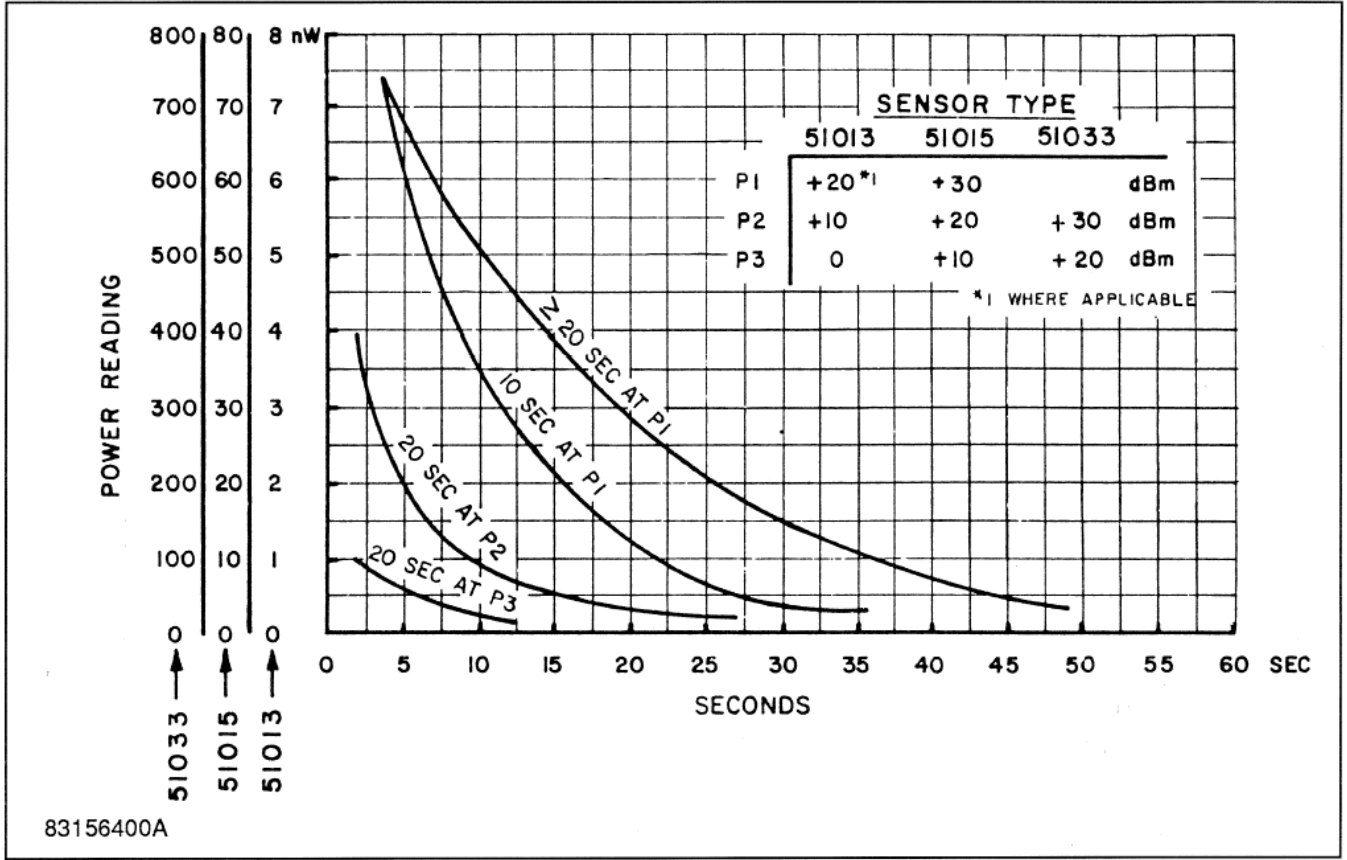
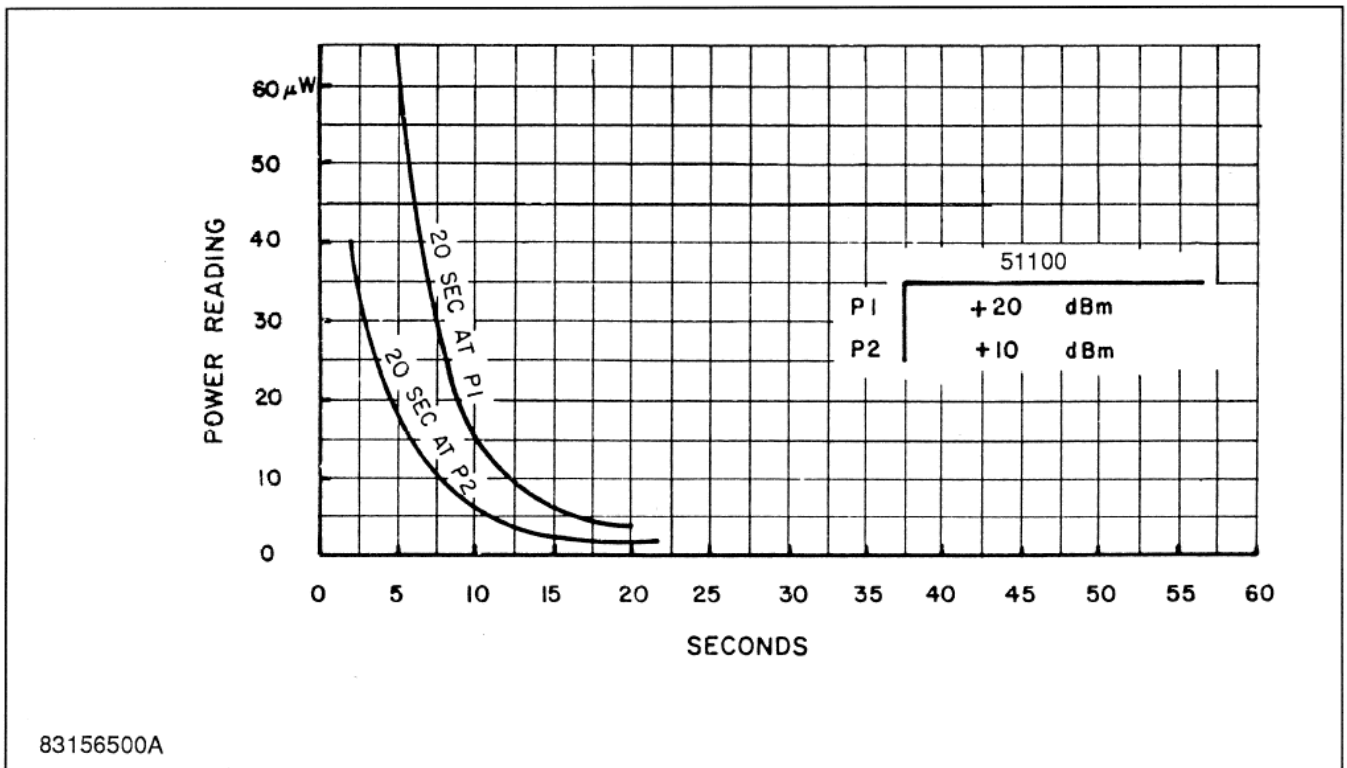

Figure 4-2 Diode Sensor Decay



# Boonton 4240 Series RF Power Meter

Figure 4-3 Thermal Sensor Decay

## 4.3 Dynamic Range

The hold range mode is useful when it is known that the signal will vary over a certain limited range. (The hold range mode is active when a specific instrument range, other than autorange, has been selected.) The dynamic range of this mode is limited by the zero offset and the resolution, as shown in Figure 4-4. It can be seen from this figure that the useful dynamic range is 20 dB if the error is to be kept below 0.1 dB. An asterisk is displayed before the channel when the measured value is below the lower range limit indicating an uncalibrated measurement.

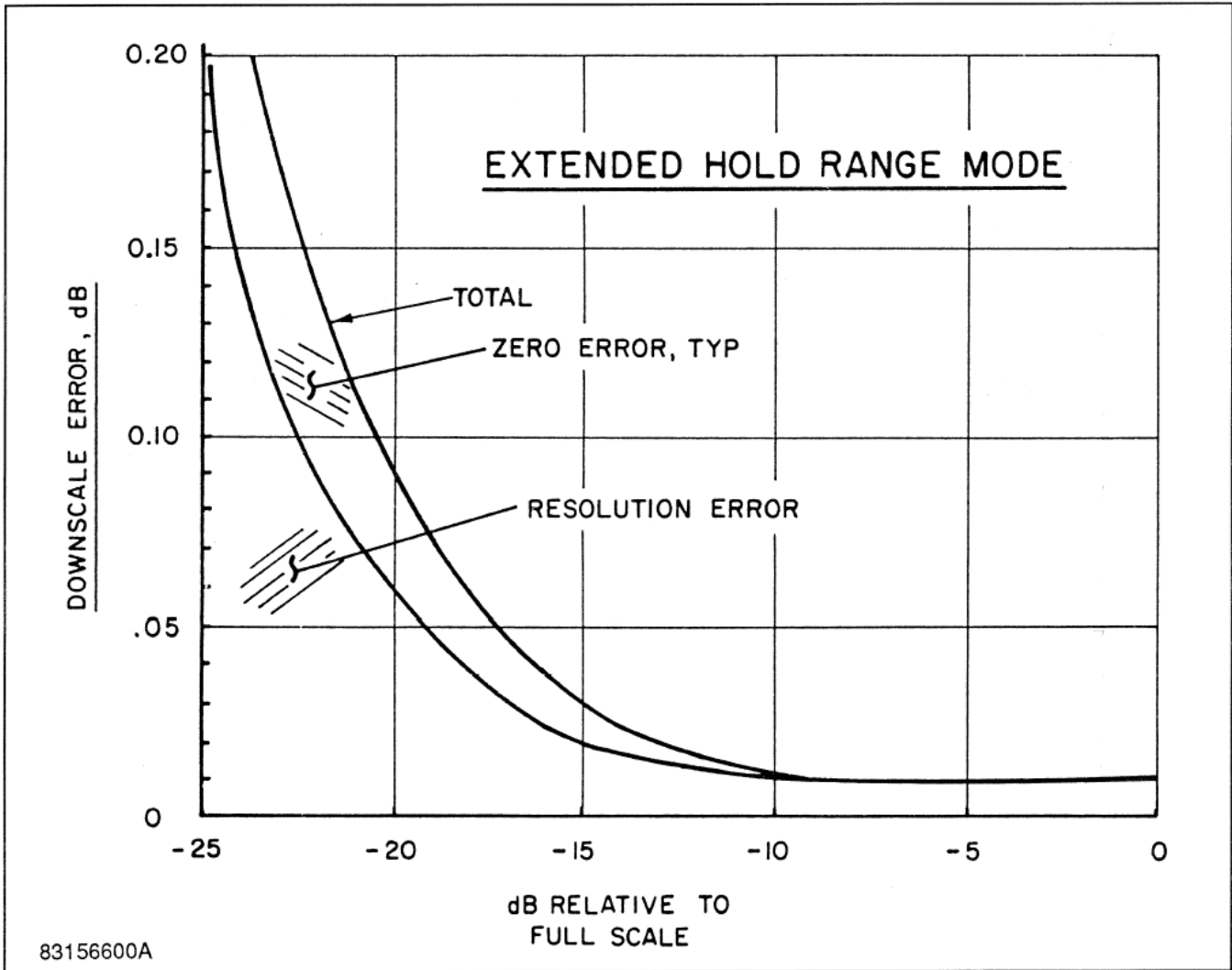

Figure 4-4. Extended Hold Range Mode

# Boonton 4240 Series RF Power Meter

## 4.4 Filtering

The Model 4240 employs digital filtering (averaging of measurements) to reduce the noise floor of the instrument and to stabilize measurements. The default values are optimized for speed and low noise under general conditions. Default values for normal and fast modes are as follows:

| Range | Normal (sec.) | Fast (sec.) |
|-------|---------------|-------------|
| 0     | 2.8           | 2.8         |
| 1     | 0.8           | 0.8         |
| 2     | 0.8           | 0           |
| 3     | 0.8           | 0           |
| 4     | 0.8           | 0           |
| 5     | 0.8           | 0           |
| 6     | 0.8           | 0           |

The filtering technique used is digital pipeline filtering, also referred to as circular filtering or moving average filtering. The displayed measurement is simply an equally weighted average of the last  $x$  seconds worth of samples, where  $x$  is the filter length in seconds. For purposes of noise and settling time, the number of samples is not important, but the time is important. For example, if a three second filter is used, the noise is the same whether 60 or 600 samples are taken in that interval, provided that the samples are taken above a certain rate. For this reason, filter selection in the Model 4240 is done on the basis of seconds, rather than the number of samples.

The bottom end sensitivity of the instrument is limited by sensor noise. An RMS noise specification is valid since the sensor noise and the amplifier noise are band-limited and Gaussian. The noise level, specified in picowatts at a certain filter length, is sufficient to calculate the error due to noise at any signal level, for any filter, as shown in the discussion of noise that follows.

## 4.5 Noise

**Noise Reduction.** The amount of noise reduction that can be realized has no theoretical limitation, except that drift enters into the picture at filter lengths over 20 seconds. The digital filter has a bandwidth and rolloff curve just as any filter does; the bandwidth can be reduced arbitrarily. The effective noise bandwidth is  $0.469/t$ , where  $t$  is the filter length. For example, with a filter length of 4 seconds, the equivalent noise bandwidth is 0.12 Hz.

Figure 4-5 is a nomograph showing the noise reduction that applies for various filter lengths, given the sensor noise with 2.8 second filtering. (This is the time for which diode sensor noise is specified.) Noise power is inversely proportional to the square root of the filter length. Normally, noise power varies directly with filter bandwidth; however, because power sensors are square-law devices (detected voltage is proportional to power), the noise power is proportional to the square root of the bandwidth. This can be demonstrated with noise measurements. At very low filter lengths (less than 150 milliseconds), however, the noise does not increase without bound for all sensors because the input amplifier noise is restricted with hardware filters. This additional filtering is not shown in the nomograph.

**Error Computation.** Since the noise is Gaussian, both before and after filtering, statistics show the level of confidence factor that can be associated with a given reading. (At medium and high power levels, the confidence factor is essentially unity.) Figure 4-6 shows a typical set of samples and a typical error band specification of 2 sigma. Under these conditions, 95.4% of the readings will fall within  $\pm 2$  sigma.

Figure 4-7 shows the confidence factor for other error bands. The error band is expressed in pW, regardless of the power level. (The percentage error band can also be calculated as shown below.) The RMS noise is taken from the sensor specifications and modified as necessary for filter lengths other than 2.8 seconds. Knowing any two of the three parameters (error band, RMS noise, and confidence factor), the third can be computed. For example, if the sensor RMS noise is 65 pW and the confidence factor is to be 95.4%, the error band is 130 pW, single sided (+130 pW). If this were the case, at a measurement level of 1300 pW the percent error band would be 10%, corresponding to about +0.44 dB.

# Boonton 4240 Series RF Power Meter

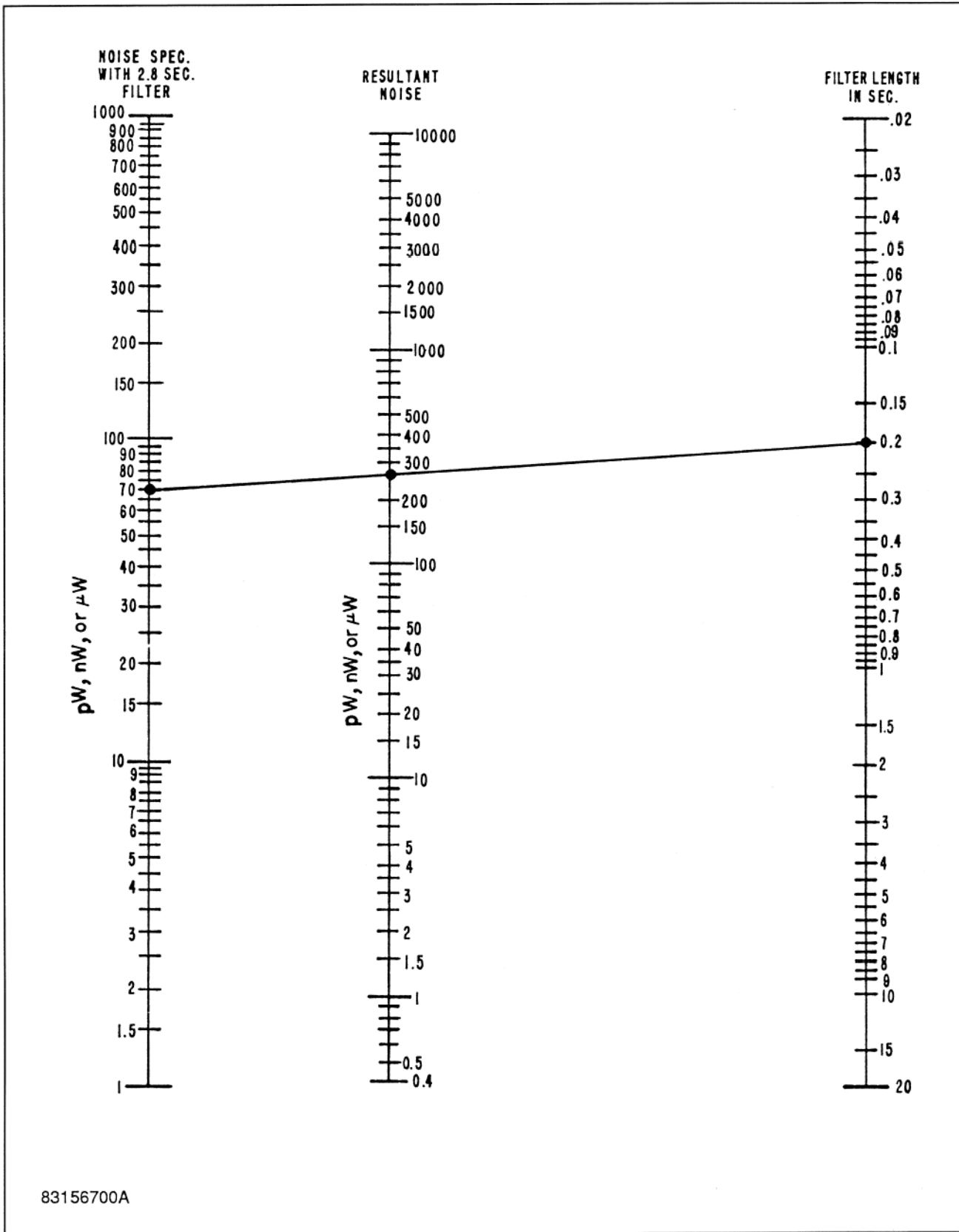

# Boonton 4240 Series RF Power Meter

Figure 4-5. Noise Reduction

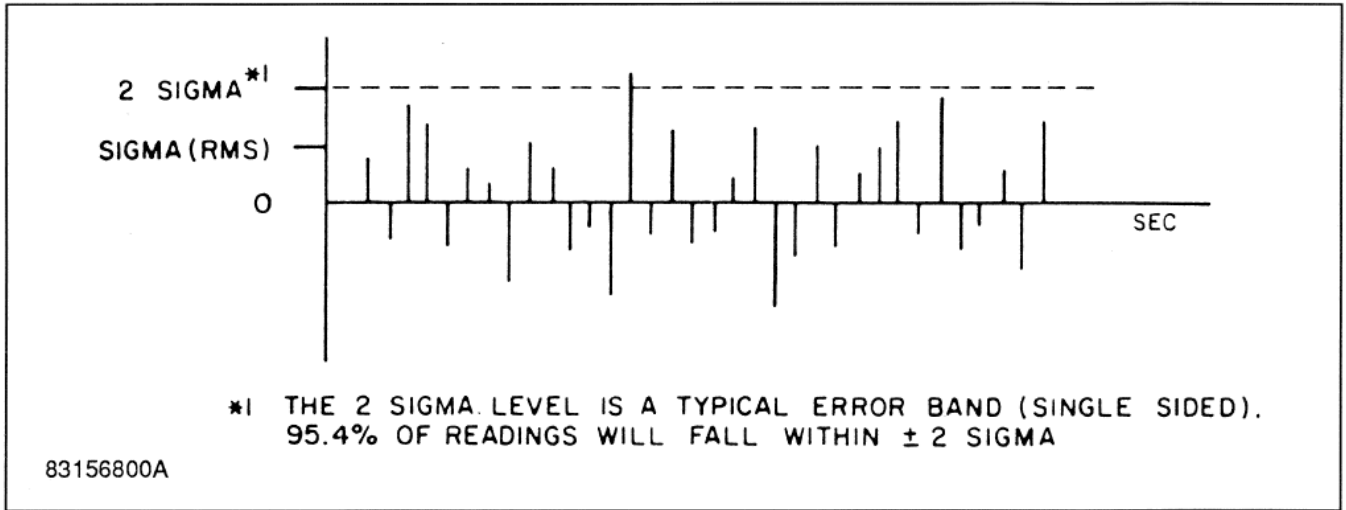

Figure 4-6. Typical Error Band Specifications

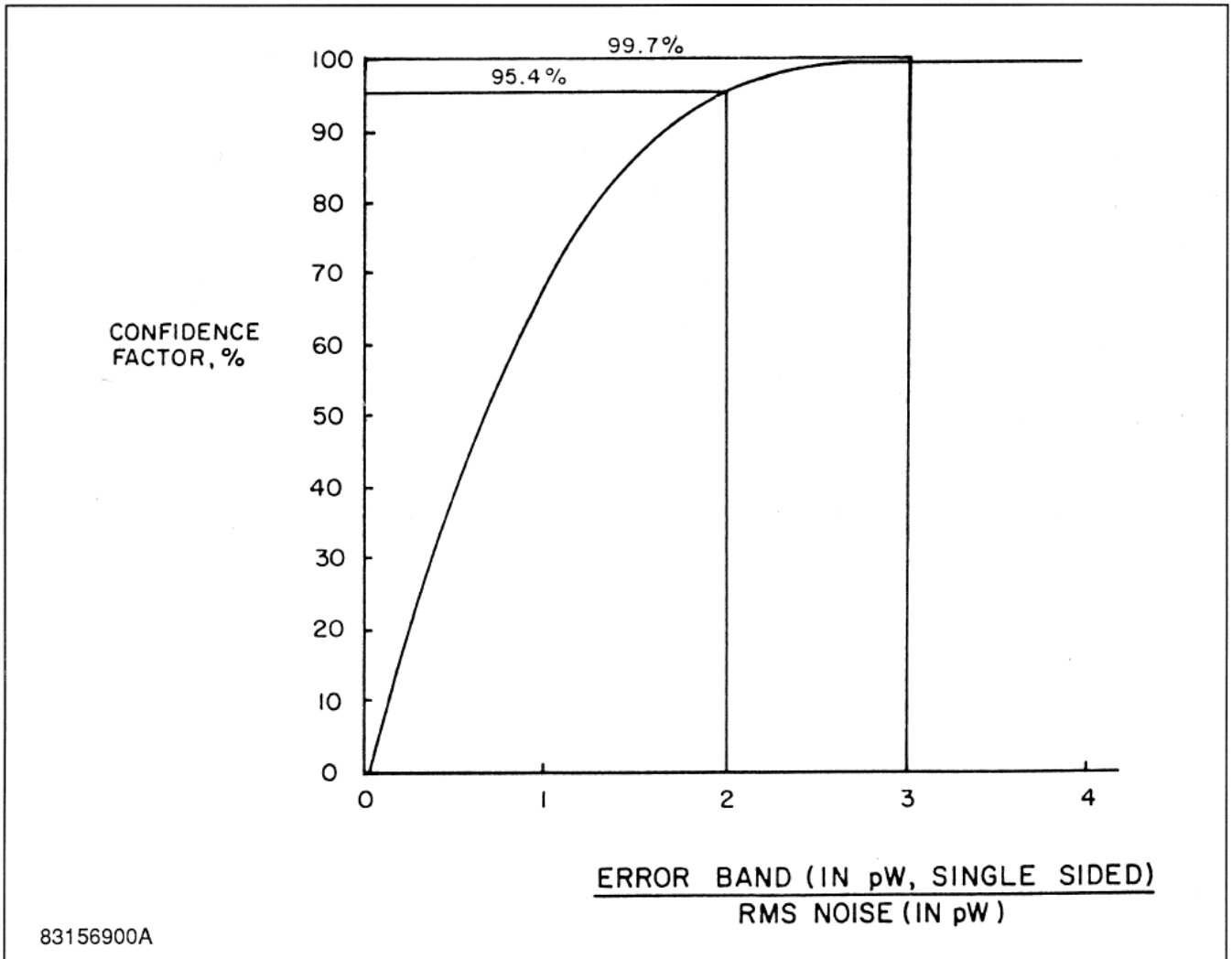
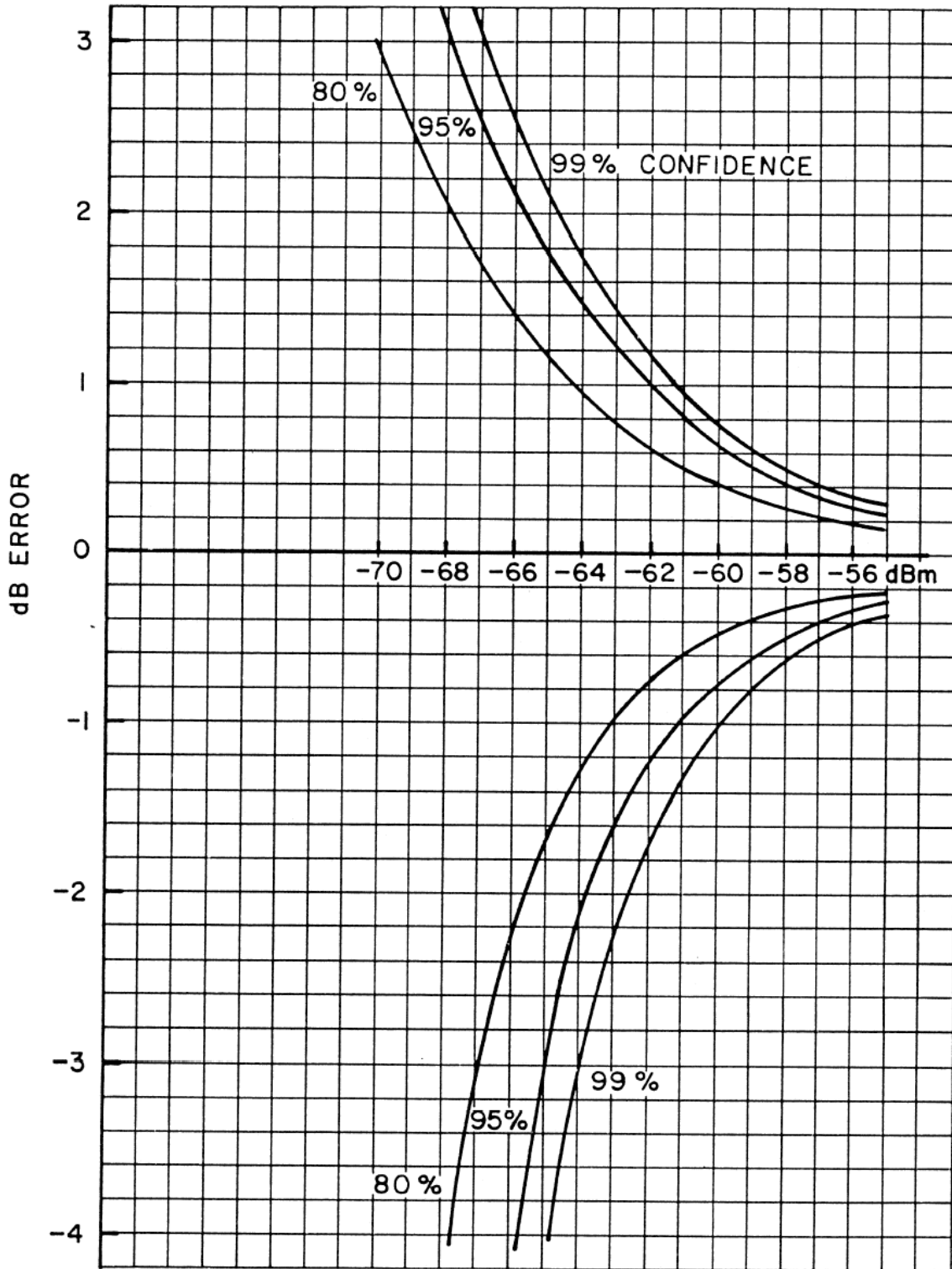

Figure 4-7. Probability of Falling within an Error Band

# Boonton 4240 Series RF Power Meter



83157000A

Figure 4-8. Confidence Curves, 51013 Sensor with 2.8 Second Filter

# Boonton 4240 Series RF Power Meter

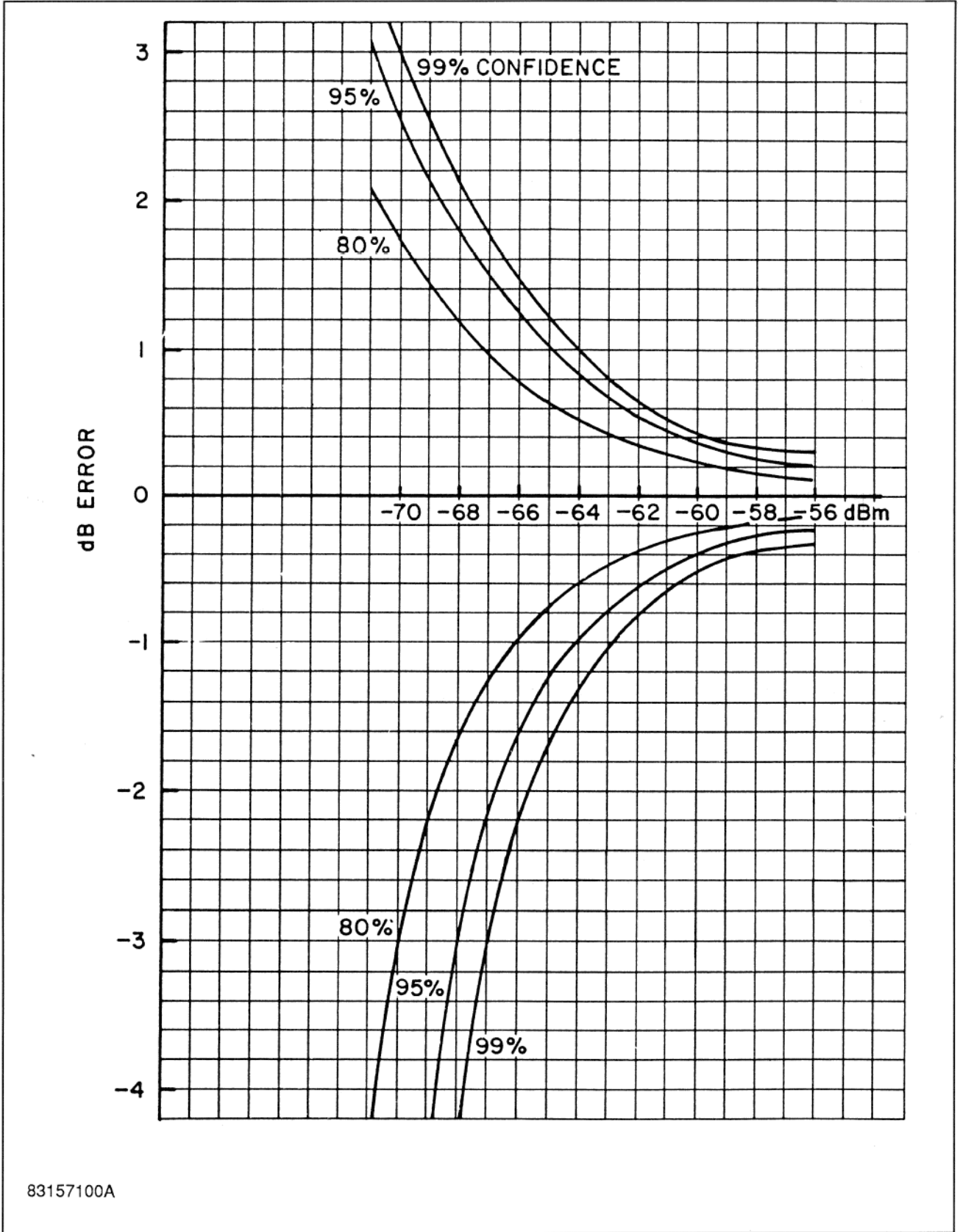

83157100A

Figure 4-9. Confidence Curves, 51013 Sensor with 10 Second Filter

# Boonton 4240 Series RF Power Meter

**Noise Error Examples.** Figures 4-8 and 4-9 show the computed error for the 51013 diode sensor at different power levels, for 2.8 and 10 second filters. To attain these results, the sensor must be at a stable temperature, and zeroing must be done immediately before the measurement is taken.

**Integration of Power.** With long filtering, instrument readings may seem erroneous because the filter has not been cleared. For example, with a 20 second filter, if a 2 second RF pulse is applied, the instrument display will indicate a nonzero level for 18 seconds after the pulse has terminated. Additional pulses will be integrated along with the first until, by the process of selective deletion, the pulses are removed one at a time from the filter. Actually, measurement samples are deleted, not the pulses, giving rise to a ramping effect at the instrument display/output. This is shown in Figure 4-10. In all senses, the filter is a simple integrator.

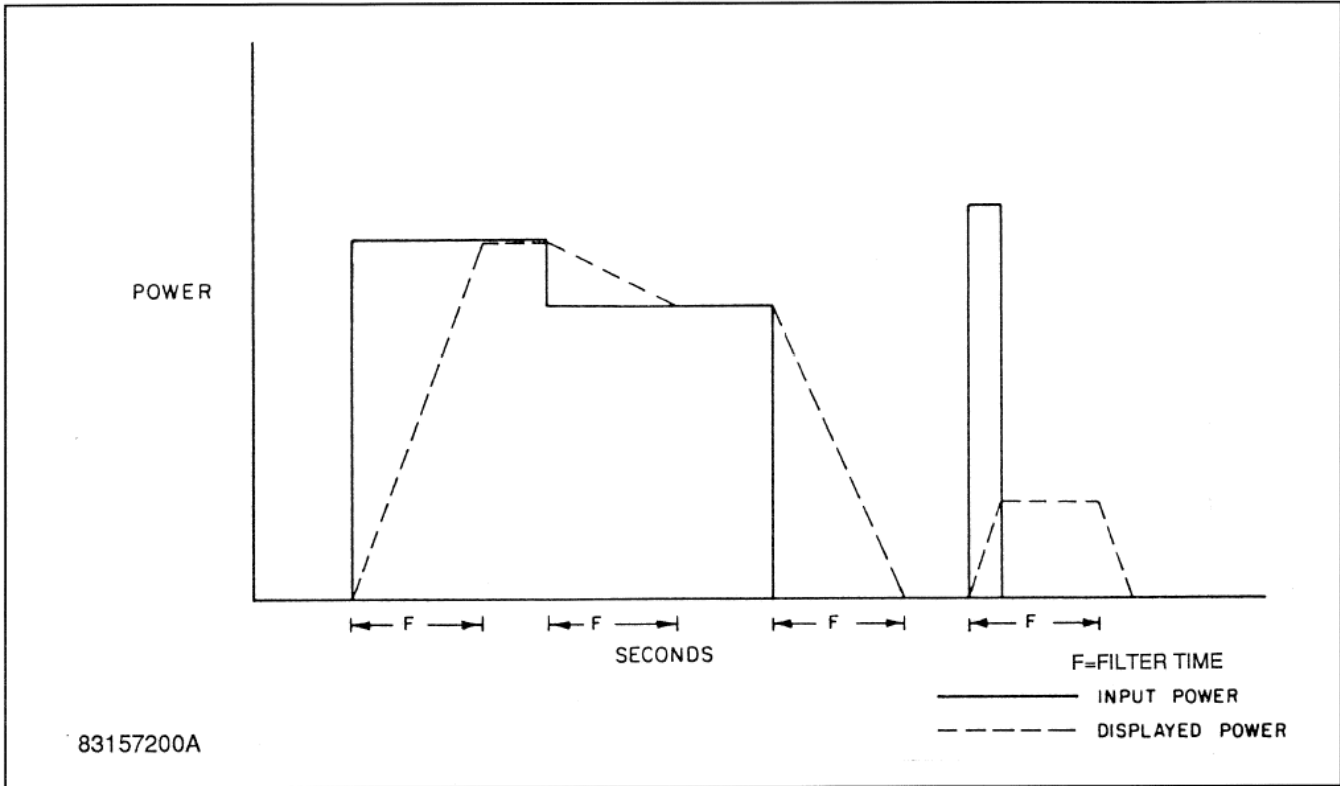

Figure 4-10. Integration of Power

**Clearing of Filter.** When long filter times are used, it may become troublesome at times to wait for the filter to clear. If the Auto filter function is selected, the filter is cleared after significant power changes, and filtering then resumes. Clearing can also be accomplished by changing the filter length to any different value and then resetting it using the interface bus; however, with bus operation, most of the trigger modes clear the filter at trigger time.

**Partial Results.** Measurement time is affected by the filter since valid readings to within a certain error band can be obtained only when the filter is full. If the filter has been cleared, data is available at reduced accuracy immediately after the first 50 millisecond sample period. The filter uses the number of samples as a divisor when computing the average, and the output/display does not ramp but homes in on the result instead as the samples accumulate.

## 4.6 Measurement Time

**Step Response.** The measurement time from a power input step is the sum of the overhead time and the length of the digital filter, where the overhead time is defined as the time delay due to sensor response time and measurement software (processing).



# Boonton 4240 Series RF Power Meter

**Continuous Response.** Regardless of the overhead time or the digital filter length, the Model 4240 will output readings at a maximum rate of about 200/second with the display operating. As the sensor and the digital filter settle, readings will ramp up or down at that rate.

**Overhead Time.** Overhead time is <350 milliseconds for diode sensors and <450 milliseconds for thermal sensors under the following conditions:

- a. Settling to 99% or 0.04 dB of final power
- b. Power step of 10 dB
- c. Range does not change
- d. Digital filter set to minimum

The power step may be upward or downward. Smaller power steps will decrease this time slightly; larger power steps in the downward direction will increase the time significantly. A 40 dB downward step, for example, will take several seconds to settle to 0.04 dB.

**Digital Filter.** The digital filter is a moving average or pipeline filter which simply integrates the readings over the last x seconds, where x is the filter length. A step input to the filter will produce a linear ramp at the output, terminating when the filter is full.

**Default Filter Lengths.** Although any filter length from 0 to 20 seconds may be chosen, default filter lengths are programmed into the instrument for optimum general conditions. (Refer to Section 4.3 Filtering.) For diode sensors, the range break-points are roughly in 10 dB steps, with the range 0 to 1 break-points at approximately -54 dBm.

**Settled Measurement Time.** In the free run settled mode, output data updates are held off until the measurements have settled.

**Fast Mode Measurement Time.** The Fast Mode can be invoked over the bus to put the instrument into its fastest sampling mode.

## 4.7 High Frequency Accuracy

Power measurements, particularly at high frequencies, have a number of uncertainties which generally arise from imperfect SWRs. If all power sources and power meters had impedances that were resistive and equal to  $Z_0$  (the characteristic impedance of the measuring system), most problems would disappear. The incident, dissipated, and maximum available powers would all be equal, and the indicated power would differ only by the inefficiency of the power sensor in converting all dissipated power to indicated power. Tuning eliminates most of the SWR effects, but is cumbersome and is therefore seldom done. The use of attenuator pads can mask imperfect SWRs, as can the use of a directional coupler to level the source and reduce its reflection coefficient to a value equal to the directivity factor of the directional coupler. Boonton 51015 and 51033 power sensors have precision, built-in attenuators which improve the SWR over that of other power sensors.

When the complex coefficients of both an imperfect source and a power sensor are not known, but the maximum actual SWRs of both are known, the maximum positive and negative uncertainties of the measured power,  $P_m$ , can be determined from Figure 4-11. For example, if the SWR of the source is known to be 1.2 and the SWR of the power sensor is 1.25, the uncertainty derived from Figure 4-11 is 2%.

# Boonton 4240 Series RF Power Meter

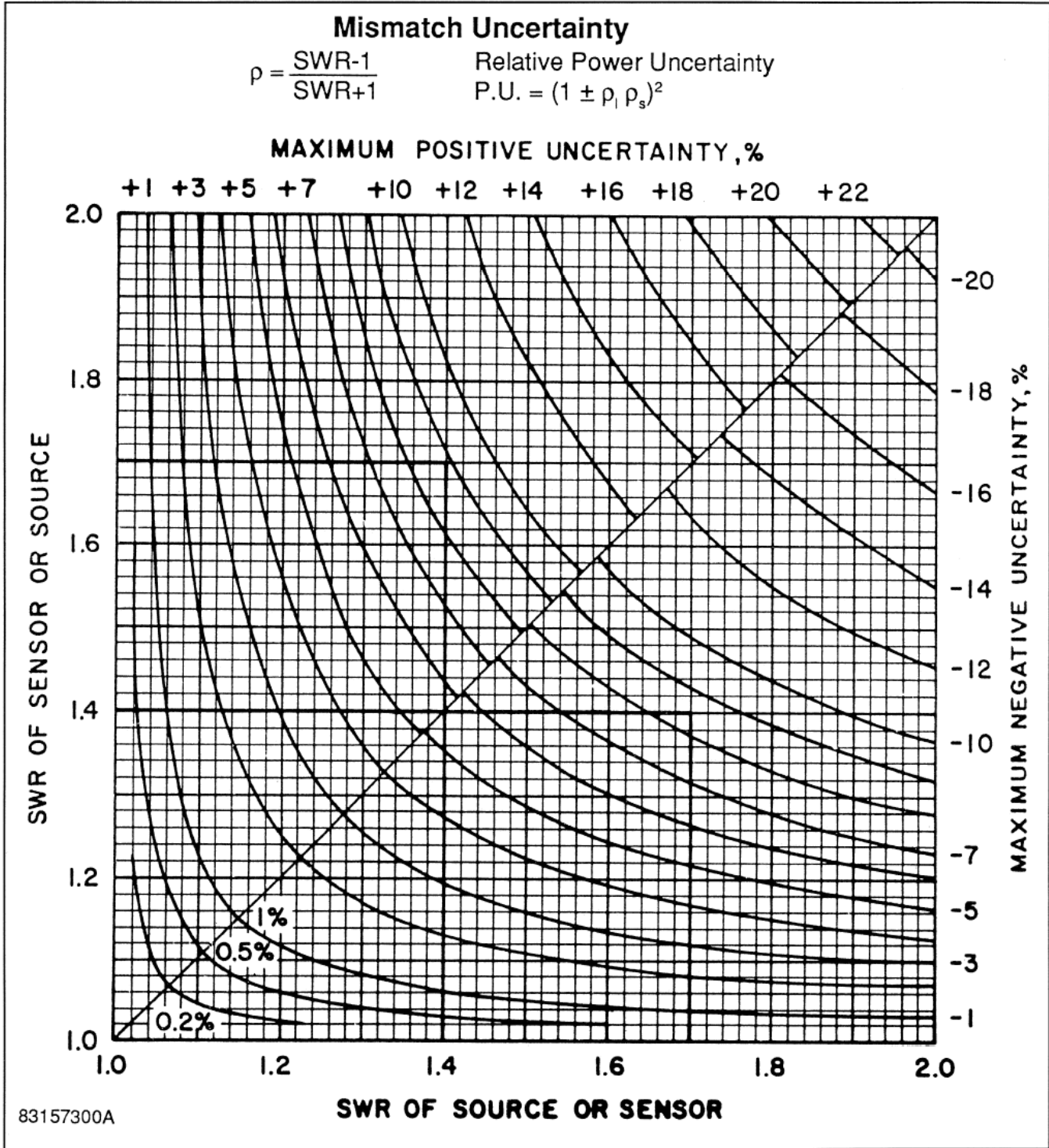

Figure 4-11. Mismatch Uncertainties Chart

## 4.8 Waveform Sensitivity

Thermal sensors are insensitive to the waveform because they average RF power over many tens of milliseconds. Modulated signals, non-sinusoidal waveforms, and even pulses can be detected without distortion of the measurement. Thermal sensors are referred to as RMS responding.

# Boonton 4240 Series RF Power Meter

Diode sensors are also RMS responding below about -20 dBm (-10 dBm and 0 dBm for attenuated models 51015 and 51033). This response characteristic is obtained because the sensors are dual diode types, and diodes respond in square-law fashion at low and medium levels. This is not an approximation, but rather an inherent effect. This effect results from the fact that the diodes do not turn on and off as switches, but behave as signal dependent resistors instead. Even with no signal input, the diodes have a finite conductance, and this conductance is modulated on a cycle by cycle basis to give a net DC offset proportional to the power.

The square-law response can be seen in Figure 4-12, where a 100% amplitude modulated signal is shown to have virtually no effect on the measured power at low levels. Of course, frequency modulated and phase modulated signals can be measured at any level, since the envelope of these modulated signals is flat. Frequency shift keyed (FSK) and quadrature modulated signals also have flat envelopes and can be measured at any power level.

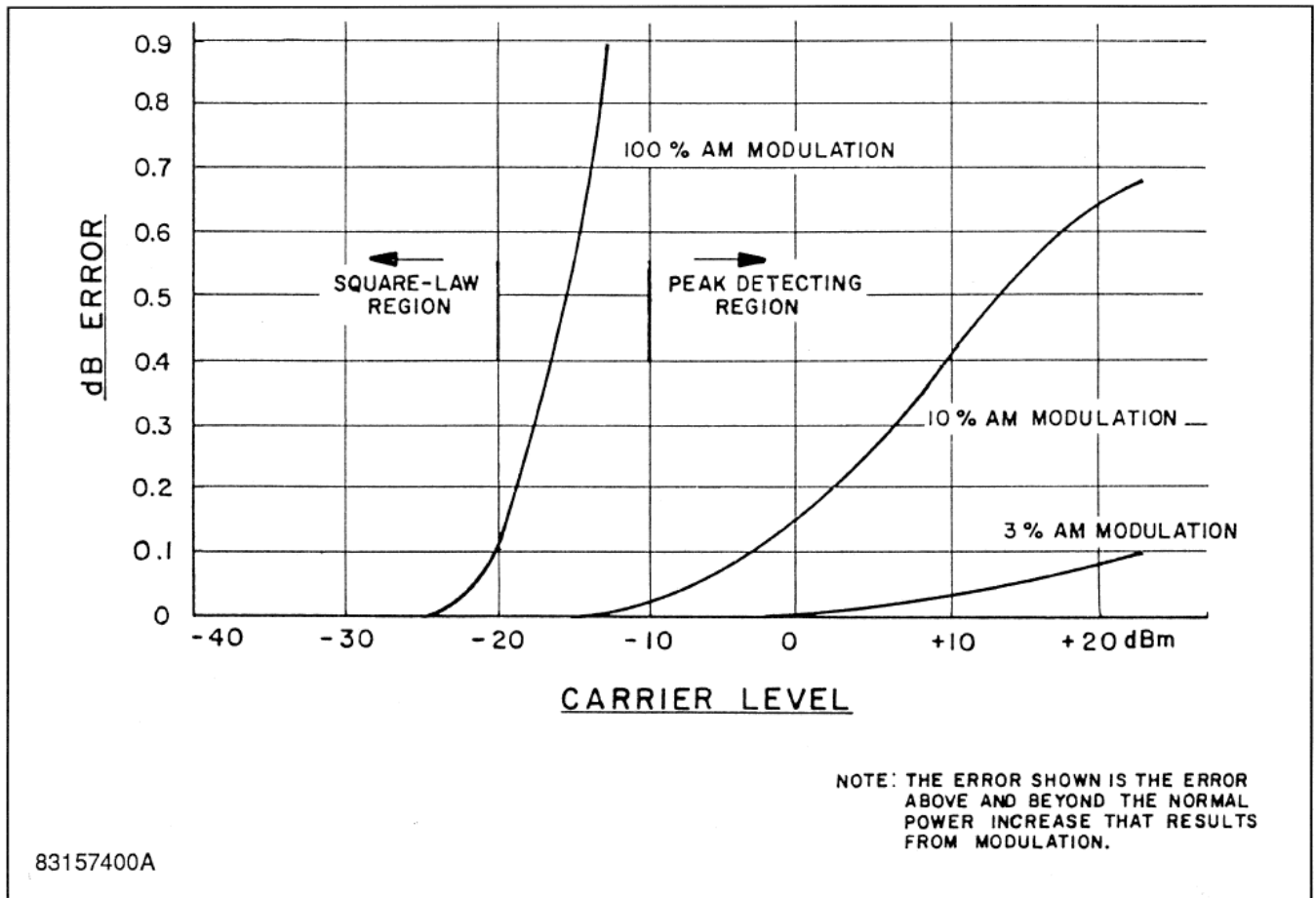

Figure 4-12. Error Due to AM Modulation (51013 Diode Sensor)

At higher power levels (above approximately -10 dBm for the 51013 sensor), the diodes operate as peak detectors. The Model 4240 is software calibrated to calculate the RF power based on a shaping transfer function (RF to DC) for each sensor type. However, only measurements of RF signals with flat envelopes (CW, FM, PM, FSK, quadrature, etc.) are valid in this region and in the transition region from -20 dBm to -10 dBm.

A special provision is made for the case of rectangular pulses where the duty cycle (on-time percentage) is known and the top level power of the pulse (pulse power) is to be measured. The duty cycle in percent is set into the DUTY entry in the CHANNELS menu. For example, if the signal consists of pulses with a duty cycle of 25%, set DUTY to 25. This will add 6 dB to the displayed power and turn on the "Pk" indicator following the units.

# Boonton 4240 Series RF Power Meter

Only the display is affected by the duty cycle calculation. The measurement process is subject to the same criteria discussed above. For thermal sensor no correction is needed for level. However, pulse periods on the order of tens of milliseconds may result in unstable readings because of inadequate averaging. If the filter time constant is too short, it can be increased by use of the AVG function.

For diode sensors, the RMS power region extends up to -30 dBm with a gradual change to peak voltage response. For accurate pulse power measurement, the power meter should read an average power of -30 dBm or less. This is the power indication when the duty cycle is set to 100%. Somewhat useful measurements can be made up to -20 dBm average power, but the uncertainty will typically be at least  $\pm 1$ dB.

Extra care should be taken when using the pulse power feature to avoid overload damage to power sensors. Pulses with small duty cycle have a very large peak to average power ratio. The average responding power meter may have a small indicated power, but the peak signal at the sensor diode or thermal element may easily exceed the maximum ratings.

## 4.9 Chart Recorder Operation

The chart recorder output is a DC voltage from 0 to 10 volts. In the Watts mode, the output voltage is equal to the digits displayed on the main data display divided by 1100 times 10. In the dBm or dBr modes, the output voltage is directly proportional to the ratio of the difference of the measured value and the sensor's lower limit to the full dynamic range of the sensor times 10. For example if the default upper limit is 23 dB and the lower limit is -75 dB for a particular sensor then at 0 dBm the corresponding Recorder Output voltage would be:  $(0 - (-75)) * 10 / (23 - (-75)) = 750 / 98 = 7.65$  volts. The sensitivity over a 10 dB range would be  $(10 * 10) / 98 = 1.02$  volts. Refer to Section 3.3.2 Sensor Key to locate the upper and lower limits of the sensor in use in determining the expected Recorder Output response.

The output impedance is 9.06 kilohms, which gives the user the option of loading it with 1 kilohm, thereby reducing the full scale output to 1 volt. The normal 12-bit resolution is still maintained with this method. With a 1 megohm load, the circuit is essentially open and the error is small. Absolute accuracy is  $\pm 5\%$ .

## 4.10 Bar Graph Operation

The meter presents the power proportionally in the following manner.

**Watts Mode.** The meter follows the digital display as a percentage of the full scale. The bar graph consists of 100 segments resulting in a 1% resolution. A main data display of 1100.0  $\mu$ W drives the meter to 100 percent of full scale while a display of 561.0  $\mu$ W drives the meter to 51 percent of full scale. The meter reads full scale at 10 dB increments.

**dBm Mode.** The meter follows the digital display as a percentage of the full scale. The bar graph consists of 100 segments resulting in a resolution of 0.1 dB/segment. A main data display of 0.00 dBm (or any 10 dB increment) drives the bar graph to zero percent of full scale while 5.00 dBm and 9.99 dBm drives the meter to 45 percent and 90 percent of full scale respectively. A value of -7 dBm would drive the meter to 27 percent of full scale while a value of -2 dBm would drive the meter to 72 percent of full scale.

**dBr Mode.** Selecting the dBr mode positions the bar graph to 50 percent of full scale when the digital display reads 0 dBr. The analog meter thereafter reads 100 percent of full scale at +5 dBr or more and zero percent of full scale at -5 dBr or less.

## 5. Remote Operation

### 5.1 GPIB Configuration

The 4240 GPIB interface is configured using the *Menu > SETUP > IEEE* menu. The primary listen/talk address (MLTA) can be set to any value from 1 to 30 inclusive. The value assigned must be unique to each GPIB device. Secondary address is not implemented.

To inform the instrument that a message has been completed, the bus controller must end all messages with a terminating character and/or EOI control signal. The Model 4240 can be programmed for several combinations of terminating characters as required by the controller employed. Selection of terminating characters is accomplished via the *Menu > SETUP > IEEE* menu. There the instrument can be programmed for individual end of string characters in both listener and talker modes as well as independently enabling the end or initiate control signal.

### 5.2 RS-232 Configuration

RS-232 interface is also available on the Model 4240. The command set and data transfer protocol are nearly identical to those for IEEE. The *Menu > SETUP > RS232* commands are used to configure the RS-232 interface to comply with the terminal in use. Setting the end-of-string character and SRQ Mask is accomplished by using the EOS Talker/Listener and SRQ Mask commands respectively.

**Entering the Remote Mode.** The Model 4240 enters the remote mode when the ASCII "SI" character (hexadecimal 0F/CTRL O) is received. In the remote state, the front panel keyboard is disabled, except for the <Menu> key which serves as the return to local function. The display will show the REM indicator on the last line and enable the TLK, LSN and SRQ as appropriate.

**Returning to Local Mode.** The instrument will return to the local state when; a) The <Menu> key is pressed or b) The ASCII "SO" character (hexadecimal 0E/CTRL N) is received.

#### Note



The instrument must be placed in the remote state for it to respond to data messages. It is not possible to store data in the local state for execution in the remote state.

**Talk Operations.** The Model 4240 can be requested to talk in two ways. The "??" mnemonic is available for requesting data via the RS-232 port. Immediately after receiving this mnemonic, the instrument responds by transmitting data based on the current talk mode. For example, the following interactive sequence causes the Model 4240 to transmit the measurement with the associated units (4230 IEEE Emulation mode):

#### Terminal Sends

O (CTRL O/hexadecimal 0F)

DB TM1 ??<ENTER>

#### Model 4240 Response

REM displayed on bottom line, indicating remote operation.

Set measurement to dBm, set the talk mode to 1 (talk measurement with units).  
Data returned: "0,-3.00 dBm" - indicating no error at -3 dBm.

#### Note



<ENTER> means transmit end-of-string as defined via the *Menu > SETUP > RS232 > EOS LSTN* parameter (typically CR).

# Boonton 4240 Series RF Power Meter

Additionally, the ASCII "DC2" character (hexadecimal 12/CTRL R) will cause the instrument to immediately transmit data based on the current talk mode. Continuing the above example:

| <b>Terminal Sends</b>     | <b>Model 4240 Response</b>                                                                                                                     |
|---------------------------|------------------------------------------------------------------------------------------------------------------------------------------------|
| TM0 <ENTER>               | Set the talk mode to send Floating Point Measurements.                                                                                         |
| R (CTRL R/hexadecimal 12) | Talk the error flag and the measurement in floating point notation.<br>Data returned: "0,-3.00" - indicating no error and the power is -3 dBm. |

The rules for number and data strings are the same as for the IEEE-488 interface. Number formats are free form and data strings are case insensitive.

## 5.3 SCPI Language

The 4240 Series instruments may be remotely controlled using commands that follow the industry-standard SCPI programming conventions. The default language is:

```
SYSTem:LANGuage SCPI
```

All of the functions of the 4240 Series are accessible remotely via SCPI commands.

### 5.3.1 SCPI Structure

The SCPI instrument model defines a hierarchical command structure based on "command nodes". Each node may contain commands or names of a next-level command node. Each command is formed of a series of keywords joined together, and delimited by a colon ":" character. The command begins with a colon at the "root node", and traverses downwards through the command tree to form a specific command. This structure is very similar to a DOS file system, where the file system begins at the root level ("."), and each directory (SCPI subsystem) may contain a list of files (SCPI commands) and lower-level directories. To execute an individual command, the entire command name ("path") must generally be specified, although there are several shortcuts available to reduce the command string length.

SCPI subsystems or command groups are usually aligned with instrument functions, and the standard provides a number of pre-defined subsystems that can be used for most instrument types. For example, the top level SENSE subsystem groups commands that are related to sensing signals (detection, amplification, digitization, linearization), while the OUTPUT subsystem contains commands that control output functions of the instrument such as voltage output or controlling an RF reference output.

### 5.3.2 Long and Short Form Keywords

Each command or subsystem may be represented by either its full keyword, or a short form of that keyword. The short form is typically the first several characters of the full name, although this is not necessarily the case. The short form of each keyword is identified in this manual by the keyword characters shown in UPPERCASE, while the long form will be shown in mixed case. For example, the short form of "CALCulate" is "calc", while the long form is "calculate". Long form and short form commands may be used interchangeably, but only the exact forms are permitted – intermediate length commands will not be recognized. Sending "CALCUL" will cause an error.

Note that not all keywords have long forms – in this case, the entire keyword will be shown in uppercase.

While uppercase and lowercase text is used to identify keywords, SCPI is generally case-insensitive, so it is acceptable to send uppercase, lowercase or mixed case keywords to the instrument. The only exception is when a command accepts a literal string argument. In this case, quotes may be used to delimit a string of user-defined case.

### 5.3.3 Subsystem Numeric Suffixes

Certain subsystems, such as the SENSE or CALCulate subsystems in the 4240 Series, often exist as more than one instance (often called a "channel" in an instrument). In this case, an optional numeric suffix may be used to define the channel. If this

# Boonton 4240 Series RF Power Meter

suffix is not present, the default channel is assumed. For example, SENSE or SENSE1 defines operation affecting the instrument's "Channel 1" measurement path, while SENSE2 commands will apply to channel 2.

## 5.3.4 Colon Keyword Separators

The colon (":") character is used similar to the way a slash or backslash is used in a filesystem. Prefixing a command string with a colon resets parsing at the root command level, and a colon must separate each keyword in the command. Beginning a new line always resets parsing to the root level, so the leading colon is optional if the command is the first command on a line.

## 5.3.5 Command Arguments and Queries

Many commands require arguments. In this case, the entire command string is sent, followed by the argument. A space is used to separate the command from the argument. For example, "SENSE:CORREction:DCYCLE 25.0" sets duty cycle correction to a value of 25.0. Arguments may be numeric, or alphanumeric. If a command requires more than one numeric argument, the arguments must be sent as a comma delimited list.

To read the current value of a particular parameter, the Query Form of its command may be used. A command query is formed by appending a question-mark ("?") suffix to the command instead of an argument list. There should not be any whitespace between the command and the suffix. For example, "SENSE:CORREction:DCYCLE?" queries the duty cycle correction parameter, and causes the instrument to return its current value.

## 5.3.6 Semicolon Command Separators

The semicolon (";") character is used to separate multiple commands on a single line. However, the parsing path is affected when more than one command is combined on a line. As noted previously, the first command of a line is always referenced to the root level whether or not the command is prefixed by a colon. However, for the second and succeeding commands, the parsing level is NOT reset to the root level, but rather referenced from the current node. This allows the parser to remain at the current node, and execute other commands from that node without resending the entire node string. For example, the following multi-command strings are equivalent:

:SENSE:CORREction:DCYCLE 25.0; :SENSE:CORREction:CALFactor 2.12; (two full-path commands)

:SENSE:CORREction:DCYCLE 25.0; CALFactor 2.12; (second command referenced to CORREction node)

SENSE:CORREction:DCYCLE 25.0; CALFactor 2.12; (leading colon omitted from first command)

If a command does not belong to the same subsystem as the preceding command on the same line, then its full path must be specified, including the colon prefix.

## 5.3.7 Command Terminators

All SCPI command strings transmitted to the instrument must be terminated. For commands sent via the GPIB bus, any character with the IEEE488 EOI (End-Or-Identify) control line asserted may be used as a terminator. This may be the last letter of the command, query or argument. Optionally, a CR (ASCII 13) and/or LF (ASCII 10) may be included.

For commands sent via the RS-232 interface a CR and/or LF must be included to match the desired protocol.

When the terminating condition is met, the SCPI path is first reset to the root level, and the received message is then passed to the SCPI parser for evaluation.

## 5.3.8 4240 Series SCPI Implementation

The SCPI Model of the 4240 provides a single or dual SENSE sub-system to handle sensor input and a matching single or dual CALCulate sub-system to process the data obtained from the sensors into useful results. The CALibration sub-system is used to calibrate power sensors. Channel dependent commands end with a number to indicate the desired channel as follows:

# Boonton 4240 Series RF Power Meter

## Examples:

|                               |                                                              |
|-------------------------------|--------------------------------------------------------------|
| :CALCulate:STATe ON           | Turn on measurement channel 1 (default channel number)       |
| :CALCulate1:STATe ON          | Turn on measurement channel 1 (specified channel number)     |
| :CALC:STAT ON                 | Turn on measurement channel 1 (short form, default chan #)   |
| :CALC1:STAT ON                | Turn on measurement channel 1 (short form, specified chan #) |
| :CALCulate:STATe?             | Query the state of measurement channel 1 (default chan #)    |
| :CALC:STAT?                   | Query the state of channel 1 (short form, default chan #)    |
| :CALCulate1:STATe?            | Query the state of measurement channel 1 (specified chan #)  |
| :CALC1:STAT?                  | Query the state of channel 1 (short form, specified chan #)  |
| :SENSe:CORREction:OFFSet 0.42 | Set channel 1 offset correction to 0.42 dB (chan units dBm)  |

In the discussion and tables below, the following notation will be used:

|                                       |                                   |
|---------------------------------------|-----------------------------------|
| Command name long and short form:     | SYSTem                            |
| Optional command name in brackets:    | SYSTem:ERRor[:NEXT]?              |
| Command with channel dependence:      | CALCulate[1 2]:STATe OFF          |
| Default channel 1:                    | CALibration:AUTO                  |
| Explicit channel 1:                   | CALibration1:AUTO                 |
| Select channel 2:                     | CALibration2:AUTO                 |
| Short Form:                           | CAL2:AUTO                         |
| Command which takes numeric argument: | SENSe1:AVERAge <numeric value>    |
| Same command; query:                  | SENSe1:AVERAge?                   |
| Command with literal text argument:   | CALCulate1:UNITs <character data> |
| Command with no query form:           | *CLS                              |
| Command with query form only:         | FETCh1:CW:POWer?                  |

## SYNTAX NOTES

*Square brackets [ ] are used to enclose the list of valid channels for a command, or a list of command options separated by the vertical separator bar | character. This character is for syntax only, and is not to be entered as part of the command. By default, if no channel number is specified, Channel 1 is selected.*

*A literal argument denoted by <character data> indicates a word or series of characters, which must exactly match one of the choices for the command. An argument denoted by <numeric value> requires a string which, when converted to a number, is within the range of valid arguments. Numerical values can generally be in any common form including decimal and scientific notation. <Boolean> indicates an argument which must be either true or false. Boolean arguments are represented by the values 0 or OFF for false, and 1 or ON for true. Queries of Boolean parameters always return 0 or 1.*

*Curly braces { } are used to enclose two or more possible choices for a mandatory entry, separated by the comma character. One of the enclosed options MUST be inserted into the command, and the braces are not to be entered as part of the command.*



# Boonton 4240 Series RF Power Meter

## 5.4 Basic Measurement Information

The easiest way to obtain a reading is by use of the MEASure command. This command initiates one complete measurement sequence which includes a default configuration. Examples are:

MEAS1:POWER?      To return the average power of channel 1, or  
MEAS1:VOLTAGE?    To return the average voltage of channel 1.

For finer control over the measurement, individual configuration and function commands should be used. Readings are obtained using the FETCH[ ]? command for current data or the READ[ ]? command for fresh data.

Readings are in fundamental units as set by the CALCulate[1|2]:UNIT command. Each reading is preceded by a condition code, which has the following meaning:

- 1      Measurement is STOPPED. Value returned is not updated.
- 0      Error return. Measurement is not valid.
- 1      Normal return. No error.
- 2      An Under-range condition exists.
- 3      An Over-range condition exists.

With the INITiate:CONTinuous OFF condition, a single measurement cycle is started by use of the INITiate[:IMMEDIATE] command, where bracketed commands are optional. Multiple triggered measurement cycles are enabled by INITiate:CONTinuous ON.

### 5.4.1 Service Request

Service requests provide a means to signal the host that a particular event or group of events have occurred in the instrument. Service requests are controlled by the Status Byte Register and the Service Request Enable Register. The Service Request Enable Register is a bit mask that determines which summary bits of the Status Byte Register can cause a request for service to be sent to the Controller. The summary bits of the Status Byte are the MAV, or Message Available bit, and three bits from event driven registers. The first of these is the Standard Event Status Register. The bits of this register are set and latched by specific events within the instrument and cleared when the register is read. The remaining two registers are the Operation Status Register and the Questionable Status Register. These two registers are similar to the Standard Event Status Register but have the additional capability to detect changes in the individual bits of the associated register's condition register. The bits are not only selected by a mask register, but a change in a selected bit, either a high to low, low to high or either transition, can be specified by transition mask registers.

The Status Byte is read by the \*STB? command. The bit enable mask is set by the \*SRE command and read by the \*SRE? query. The Standard Event Status Register is read by the \*ESR? Command and the bit enable mask is set by the \*ESE command or read by the \*ESE? Command.

The Operation Status Register is read by the STATUS:OPERation:CONDition? command. The transition masks are set by the STATUS:OPERation:NTransition and STATUS:OPERation:PTransition commands. The bit enable mask is set by the STATUS:OPERation:ENABLE command and read by the STATUS:OPERation:ENABLE? query. The Operation Event Register is read by the STATUS:OPERation:EVENT? query.

The Questionable Event Status Register has the same structure as the Operation Status Register. Refer to the command descriptions that follow for detailed information.

# Boonton 4240 Series RF Power Meter

## 5.5 SCPI Command Reference

This section contains a list of all SCPI remote commands accepted by the 4240 Series. The list is grouped by SCPI subsystem or IEEE488.2 function, and includes a detailed description of each command.

### 5.5.1 IEEE 488.2 Commands

The purpose of IEEE488.2 commands is to provide management and data communication instructions for the system by defining a set of “\*” commands (an asterisk followed by a three character code). These commands allow device control and status monitoring, and are the basis for some of the commands of the SCPI STATus subsystem (see Section 5.5.12).

#### \*CLS

Description: Clear Status command. This command resets the SCPI status registers (Questionable Status and Operation Status), the error queue, the IEEE488.2 Status Byte (STB) and Standard Event Status (ESR) registers, and the measurement.

Syntax: \*CLS

Argument: None

#### \*ESE

Description: Set or return the Standard Event Status Enable Register. The mask value in this register is used to enable bits of the Standard Event Status Register that are or'ed together to form the ESB summary bit in the instrument Status Byte. When a mask bit is set, and the corresponding ESR bit goes true, an SRQ will be generated, provided the Event Status Summary bit (ESB, bit 5) is enabled in the SRE register. No SRQ can be generated for that condition if the mask bit is cleared. To clear the entire Standard Event Status Enable Register, send \*ESE = 0. See the \*ESR command for bit assignments. This register is not cleared by \*CLS, \*RST or DCLR.

Syntax: \*ESE <numeric value>

Argument: <numeric value> = 0 to 255

# Boonton 4240 Series RF Power Meter

## \*ESR?

Description: Return the current value of the Standard Event Status Register, then clear the register. This register has bits assigned to a number of possible events or conditions of the instrument. When the event occurs, the corresponding bit is latched. The register value is read using this command. Individual bits may be enabled or disabled for SRQ generation using the ESE mask (see \*ESE command). The following table shows the bit assignments in the Standard Event Status Register:

| Bit | Value | Definition                                                                      |
|-----|-------|---------------------------------------------------------------------------------|
| 0   | 1     | Operation Complete Flag 1 = all current operations have completed execution.    |
| 1   | 2     | Not used                                                                        |
| 2   | 4     | Not used                                                                        |
| 3   | 8     | Device Dependent Error 1 = the instrument encountered a device dependent error. |
| 4   | 16    | Not used always returns 0                                                       |
| 5   | 32    | Command Error 1 = a remote interface command error exists.                      |
| 6   | 64    | Not used always returns 0                                                       |
| 7   | 128   | Not used always returns 0                                                       |

Syntax: \*ESR?

Returns: Current Value of Event Status Register (0 to 255)

## \*IDN?

Description: Return the instrument identification string. This string contains the manufacturer, model number, serial number and firmware version number.

Syntax: \*IDN?

Returns: < Mfgr, Model#, Serial#, Version# >

## \*OPC

Description: Clears the OPC (Operation Complete) status flag. This command is issued before the command to be checked for completion. After this, the flag may be queried by \*OPC? until a value of one is returned, indicating the command has completed. Note that the query is not a true query - a value of zero will never be returned.

Syntax: \*OPC

Argument: None

## \*OPC?

Description: This command examines the OPC (Operation Complete) status flag and returns a "1" if all pending operations are complete. If pending operations are not yet complete, it does not return.

Syntax: \*OPC?

Returns: Always returns 1 to indicate operations complete. Otherwise, does not return.

## Boonton 4240 Series RF Power Meter

### \*OPT?

Description: Return the status of Channel 1 and Channel 2 followed by a list of installed options.

Syntax: \*OPT?

Returns: <f1, f2, f3, f4, opt1, opt2, ...> : f1 – Chan 1 installed?, f2 – Chan1 sensor present?, f3 – Chan 2 installed?, f4 – Chan 2 sensor present?, opt1, opt2, etc. (option list may be empty).

### \*RST

Description: Set the instrument to a known “default” configuration. Set measurements to STOP. Set the sensor temperature offset flag to FALSE, set the SCPI file over-write permission to FALSE, turn the internal Calibrator output OFF and clear the error queues. System communication parameters are not changed. Instrument measurement functions are set their default values (See Table 3-3, **Initialized Parameters**).

Syntax: \*RST

Argument: None

### \*SRE

Description: Set or return the mask value in the Service Request Enable Register. This value is used to enable particular bits for generating a service request (SRQ) over the GPIB when certain conditions exist in the Status Byte register. When a mask bit in the SRE Register is set, and the corresponding STB register bit goes true, an SRQ will be generated. No SRQ can be generated for that condition if the mask bit is clear. The bits in the Status Byte register are generally summary bits, which are the logical OR of the enabled bits from other registers. See the \*STB command for bit assignments.

Syntax: \*SRE <numeric value>

Argument: <numeric value> = 0 to 255

## Boonton 4240 Series RF Power Meter

### \*STB?

Description: Return the current value of the Status Byte register. This register has bits assigned to a number of possible events or conditions of the instrument. The register value may be read using this command, or may be used to generate a service request (SRQ) over the GPIB when certain conditions exist. Individual bits may be enabled or disabled for SRQ generation using the SRE mask (see \*SRE command). Note that the bits in the Status Byte register are generally summary bits, which are the logical OR of the enabled bits from other registers. The following table shows the bit assignments in the Status Byte register:

| Bit | Value | Definition                  |                                                     |
|-----|-------|-----------------------------|-----------------------------------------------------|
| 0   | 1     | Not used                    |                                                     |
| 1   | 2     | Not used                    |                                                     |
| 2   | 4     | Error/Event queue status    | 1 = there is at least one event in the error queue. |
| 3   | 8     | QUEStionable Status Summary | 1 = an enabled QUEStionable condition is true.      |
| 4   | 16    | Message AAvailable flag bit | 1 = an output message is ready to transmit.         |
| 5   | 32    | Event Status Summary        | 1 = an enabled Event Status condition is true.      |
| 6   | 64    | MSS Summary Status          | 1 = at least one other Status Byte bit is true.     |
| 7   | 128   | OPERation Status Summary    | 1 = an enabled OPERation condition is true.         |

Syntax: \*STB?

Returns: Current Value of Status Byte register (0 to 255)

### \*TRG

Description: Simulate the bus trigger command. This command has the same effect as the GPIB command GET (Group Execute Trigger), except it must be parsed and decoded before the action takes place. There is no query form of this command.

Syntax: \*TRG

Argument: None

### \*TST?

Description: Self-test query. This command initiates a self-test of the instrument, and returns a result code when complete. The result is zero for no errors, or a signed, 16-bit number if any errors are detected.

Syntax: \*TST

Returns: Error Code

### \*WAI

Description: Wait command. This command insures sequential, non-overlapped execution. The 4240 always operates in non-overlapped, sequential mode, therefore this command is accepted as valid, but takes no action.

Syntax: \*WAI

Argument: None

# Boonton 4240 Series RF Power Meter

## 5.5.2 CALCulate Subsystem

The CALCulate group of the command subsystem is used to configure post acquisition data processing. Functions in the CALCulate subsystem are used to configure the measurement mode and control which portions of the acquired measurement data is used and how it is processed to yield a finished measurement. In addition to measurement mode, CALCulate is used to define mathematical operations, measurement units, and limit monitoring. The numeric suffix of the CALCulate program mnemonic in the CALCulate commands refers to a processing and display “channel”, that is CALCulate1 and CALCulate2 represent the power meter’s Channel 1 and Channel 2 functions. The CALCulate commands generally DO NOT affect the data acquisition portion of the measurement (see the SENSE subsystem, Section 5.5.11 ). In a signal-flow block diagram, the CALCulate block operations will follow those of the SENSE block. Note that CALCulate2 commands will generate an error if used with a single channel Model 4241.

### **CALCulate:LIMit:CLEar[:IMMEDIATE]**

Description: Clear all latched alarms for the selected channel.  
Syntax: CALCulate[1|2]:CLEar[:IMMEDIATE]  
Argument: None

### **CALCulate:LIMit:FAIL?**

Description: Returns the status of all limit alarms for the specified channel in five flags. The first flag is the logical sum of the remaining four. They are: low-limit active, high-limit active, low-limit latched and high-limit latched. Active means that the limit is exceeded when the command is executed; Latched means that the limit has been exceeded since the last limit clear command.  
Syntax: CALCulate[1|2]:LIMit:FAIL? <Boolean1>, ... <Boolean5>  
Returns: <Boolean1> = summary, <Boolean2> = low-limit active, <Boolean3> = high limit active, <Boolean4> = low-limit latched, <Boolean5> = high-limit latched

### **CALCulate:LIMit:LOWer[:POWER]**

Description: Set or return the lower limit power level for the selected channel. This limit is used for level alarms. When the measured average power is below the lower limit, a down arrow ▼ will appear on the display to the left of the measured value, and flag bits are set in the alarm register which may be accessed using CALCulate:LIMit:FAIL? query and CALCulate:LIMit:CLEAR commands.  
Syntax: CALCulate[1|2]:LIMit:LOWer[:POWER] <numeric value>  
Argument: <numeric value> = -99.99 to +99.99 dBm

# Boonton 4240 Series RF Power Meter

## **CALCulate:LIMit:UPPer[:POWer]**

Description: Set or return the upper limit power level for the selected channel. This limit is used for level alarms. When the measured average power is above the upper limit, an up arrow ▲ will appear on the display to the left of the measured value and flag bits are set in the alarm register which may be accessed using CALCulate:LIMit:FAIL? query and CALCulate:LIMit:CLEAR commands.

Syntax: CALCulate[1|2]:LIMit:UPPer[:POWer] <numeric value>

Argument: <numeric value> = -99.99 to +99.99 dBm

## **CALCulate:LIMit:LOWer:STATe**

Description: Set or return the lower limit alarm system state for the selected channel. When the lower alarm is enabled (ON), the measured average power is compared to the preset lower power limit, and the error flag is set if out of range. When OFF, no action occurs if the power is out of range.

Syntax: CALCulate[1|2]:LIMit:LOWer:STATe <Boolean>

Argument: <Boolean> = { 0, 1, OFF, ON }

## **CALCulate:LIMit:UPPer:STATe**

Description: Set or return the upper limit alarm system state for the selected channel. When the upper alarm is enabled (ON), the measured average power is compared to the preset upper power limit, and the error flag is set if out of range. When OFF, no action occurs if the power is out of range.

Syntax: CALCulate[1|2]:LIMit:UPPer:STATe <Boolean>

Argument: <Boolean> = { 0, 1, OFF, ON }

## **CALCulate:LIMit[:BOTH]:STATe**

Description: Set or return the combined upper and lower limit alarm system state for the selected channel. When alarms are enabled (ON), the measured average power is compared to the preset upper and lower limits, and the error flags are set if out of range. When OFF, no action occurs if the power is out of range. A query returns 1 if either the upper or lower limit alarm is enabled. A query forces both upper and lower ON if either is enabled.

Syntax: CALCulate[1|2]:LIMit[:BOTH]:STATe <Boolean>

Argument: <Boolean> = { 0, 1, OFF, ON }

# Boonton 4240 Series RF Power Meter

## **CALCulate:MATH:ARGA**

Description: Set or return the first argument to be used for channel math operations.

Syntax: CALCulate:MATH:ARGA <character data>

Argument: <character data> = { CH1, CH2 }

## **CALCulate:MATH:ARGB**

Description: Set or return the second argument to be used for channel math operations.

Syntax: CALCulate:MATH:ARGB <character data>

Argument: <character data> = { CH1, CH2 }

## **CALCulate:MATH:DATA?**

Description: Returns the channel math result.

Syntax: CALCulate:MATH:DATA?

## **CALCulate:MATH:OPERator**

Description: Set or return the channel math operator.

Syntax: CALCulate:MATH:OPERator <character data>

Argument: <character data> = { CH\_SUM, CH\_DIFF, CH\_RAT }

## **CALCulate:MODE**

Description: Set or return the system remote measurement mode. These measurement modes are only available under bus control. NORMal is the default mode of operation at approximately 20 readings per second. FAST returns data at over 200 readings per second. FILTered will only return data when the filter is full. FILTered works best when INITiate:CONTinuous is OFF and a trigger is issued. In this case the measurement will not be returned until the filter is full. When the instrument is returned to local the MODE defaults to NORMal.

Syntax: CALCulate:MODE <character data>

Argument: <character data> = { NORMal, FAST, FILTered }



# Boonton 4240 Series RF Power Meter

## **CALCulate:REFerence:COLLect**

Description: For the selected channel, make the current power the reference level for ratiometric measurements, replacing the previous reference level.

Syntax: CALCulate[1|2]:REFerence:COLLect

Argument: None

## **CALCulate:REFerence:DATA**

Description: For the selected channel, set the power level specified by the argument as the reference level for ratiometric measurements, replacing the previous reference level.

Syntax: CALCulate[1|2]:REFerence:DATA <numeric value>

Argument: <numeric value> = -99.99 dBm to +99.99 dBm

## **CALCulate:REFerence:STATe**

Description: For the selected channel, sets or returns the state of the ratiometric measurement mode. The ratiometric mode causes the reading to be expressed relative to a user specified value. The resulting reading will have units of dBr (dB relative) or percentage depending upon the type of units in use. When the ratiometric mode is disabled, the reading will be restored to express a power or voltage level.

Syntax: CALCulate[1|2]:REFerence:STATe <Boolean>

Argument: <Boolean> = { 0, 1, OFF, ON }, accepts all, returns OFF, ON

## **CALCulate:STATe**

Description: Set or return the measurement state of the selected channel. When ON, the channel performs measurements; when OFF, the channel is disabled and no measurements are performed.

Syntax: CALCulate[1|2]:STATe <Boolean>

Argument: <Boolean> = { 0, 1, OFF, ON }, accepts all, returns OFF, ON

Restrictions: Only pertains to channel 2 of the 4242. Channel 1 cannot be individually disabled. 1 is accepted as the default argument but no action is taken.

## **CALCulate:UNITs**

Description: Set or return units for the selected channel. For power sensors, voltage is calculated with reference to the sensor input impedance. Note that for ratiometric results, logarithmic units will always return dBr (dB relative) while linear units return percent.

Syntax: CALCulate[1|2]:UNITs <character data>

Argument: <character data> = {DBW, DBMW, DBUW, DBNW, WATTS, VOLTS, DBV, DBMV, DBUV, DBNV}

# Boonton 4240 Series RF Power Meter

## 5.5.3 CALibration Subsystem

The CALibration group of commands is used to control automatic zero offset and linearity adjustments to the RF power sensor and the channel to which it is connected. Zero offset adjustment can be performed at any time if no RF signal is applied to the sensor. Linearity calibration requires that the sensor be connected to the instrument's built-in RF calibrator.

The numeric suffix of the CALibration commands refers to a measurement channel, that is CALibration1 and CALibration2 refer to CH1 and CH2 input channels, respectively.

Note that CALibration2 commands will generate an error if used with a single channel Model 4241. Also note that although CALibration commands do not accept any arguments, all have a query form, which returns a status code upon completion of the zero or calibration process. This allows the user to determine when the process has completed, and whether or not it was successful.

### CALibration:AUTOcal

Description: Performs a multi-point sensor gain calibration of the selected sensor with the internal 50 MHz calibrator. This procedure calibrates the sensor's linearity at a number of points across its entire dynamic range.

Syntax: CALibration[1|2]:AUTOcal[?]

Returns: 0 if successful, 1 otherwise (using query form only)

### CALibration:FIXedcal

Description: Performs a calibration at a fixed frequency and level. Fixed-cal does provide for automatic control of the internal 50 MHz calibrator setting the output level to 0 dBm prior to performing the calibration. The RF output level of any other source in use must be set to 0 dBm by the user. Fixed-cal assumes that a valid Zero has already been performed.

Syntax: CALibration[1|2]:FIXedcal[?]

Returns: 0 if successful, 1 otherwise (using query form only)

### CALibration:ZERO

Description: Performs a zero offset null adjustment. The sensor does not need to be connected to any calibrator for zeroing – the procedure is often performed in-system. However, this command will turn off the internal calibrator prior to zeroing to avoid the need to perform this step explicitly.

Syntax: CALibration[1|2]:ZERO[?]

Returns: 0 if successful, 1 otherwise (using query form only)

# Boonton 4240 Series RF Power Meter

## 5.5.4 DISPlay Subsystem

The DISPlay group of commands is used to control the selection and presentation of measurements.

### DISPlay:ACTive[?]

Description: Set or return the active channel for talk commands.  
Syntax: DISPlay:ACTive <numeric value>  
Argument: <numeric value> = 1 to 2

### DISPlay:CLEar

Description: Clear all data buffers for CH1 and CH2. Clears averaging filters to empty. Does NOT clear errors.  
Syntax: DISPlay:CLEar

### DISPlay:LIN:RESolution

Description: Set or return the display resolution for linear power and voltage readings. The number of significant digits displayed is equal to the argument. This command also sets the resolution of measurements returned in remote mode.  
Syntax: DISPlay[1|2]:LIN:RESolution <numeric value>  
Argument: <numeric value> = 3 to 5

### DISPlay:LOG:RESolution

Description: Set or return the display resolution for logarithmic power and voltage readings. The number of decimal places displayed is equal to the argument. This command also sets the resolution of measurements returned in remote mode.  
Syntax: DISPlay[1|2]:LOG:RESolution <numeric value>  
Argument: <numeric value> = 1 to 3

### DISPlay:LABel:MODE

Description: Turns on/off the user message display mode enabling the user to place text messages on the front panel display.  
Syntax: DISPlay:LABel:MODE <Boolean>  
Argument: <Boolean> = { 0, 1, OFF, ON }

# Boonton 4240 Series RF Power Meter

## **DISPlay:LABel:TEXTA**

Description: Displays a text message of up to 20 characters in the first label field when Display Label Mode is enabled.

Syntax: DISPlay:LABel:TEXTA <alphanumeric value>

Argument: <alphanumeric value> = A to Z, a to z, 0 to 9, ! @ # \$ % ^ & \* ( ) \_ - + = { } [ ] ? / < > : .

## **DISPlay:LABel:TEXTB**

Description: Displays a text message of up to 20 characters in the second label field when Display Label Mode is enabled.

Syntax: DISPlay:LABel:TEXTB <alphanumeric value>

Argument: <alphanumeric value> = A to Z, a to z, 0 to 9 ! @ # \$ % ^ & \* ( ) \_ - + = { } [ ] ? / < > : .

## **DISPlay:LABel:TEXTC**

Description: Displays a text message of up to 20 characters in the third label field when Display Label Mode is enabled.

Syntax: DISPlay:LABel:TEXTC <alphanumeric value>

Argument: <alphanumeric value> = A to Z, a to z, 0 to 9 ! @ # \$ % ^ & \* ( ) \_ - + = { } [ ] ? / < > : .

## **DISPlay:LABel:TEXTD**

Description: Displays a text message of up to 20 characters in the fourth label field when Display Label Mode is enabled.

Syntax: DISPlay:LABel:TEXTD <alphanumeric value>

Argument: <alphanumeric value> = A to Z, a to z, 0 to 9 ! @ # \$ % ^ & \* ( ) \_ - + = { } [ ] ? / < > : .

# Boonton 4240 Series RF Power Meter

## 5.5.5 FETCh Queries

The FETCh? group of queries is used to return specific measurement data from a measurement cycle that has been INITiated and is complete or free-running. FETCh? performs the data output portion of the measurement. FETCh? does not start a new measurement, so a series of FETCh? queries may be used to return more than one set of processed measurements from a complete set of acquired data. FETCh? usually returns the current value of measurements, and should be used anytime free running data acquisition is taking place (INITiate:CONTinuous ON). If FETCh? is used for single measurements (INITiate:CONTinuous OFF), no data will be returned until a measurement has been INITiated and is complete.

### FETCh:CW:POWer?

Description: Return current average amplitude reading in channel units.  
Syntax: FETCh[1|2]:CW:POWer?  
Returns: CC, average power  
Where CC is the measurement condition code.

### FETCh:KEY?

Description: Return the key code of the last key depressed; e.g. MENU = 1.  
Syntax: FETCh:KEY?  
Returns: key code

| Key         | Code |
|-------------|------|
| Menu        | 1    |
| Sensor      | 2    |
| FREQ        | 4    |
| AVG         | 8    |
| Zero/Cal    | 16   |
| REF Level   | 32   |
| Up Arrow    | 64   |
| Left Arrow  | 128  |
| Enter       | 256  |
| Right Arrow | 512  |
| Down Arrow  | 1024 |

# Boonton 4240 Series RF Power Meter

## 5.5.6 INITiate and ABORt Commands

The purpose of the INITiate group of commands is to start and control the process of data acquisition once a measurement has been configured. Depending on settings, the 4240 RF Power Meter may be commanded to begin either a single measurement (INITiate:CONTInuous OFF) which stops when complete, or enter a “free-run” mode where data acquisition occurs continuously (INITiate:CONTInuous ON). The ABORt command terminates any operation in progress and prepares the instrument for an INITiate command.

### ABORt

Description: Terminates any measurement in progress and resets the state of the trigger system. Note that ABORt will leave the measurement in a stopped condition with all current measurements cleared, and forces INITiate:CONTInuous to OFF.

Syntax: ABORt

Argument: None

### INITiate:CONTInuous

Description: Set or return the data acquisition mode for single or free-run measurements. If INITiate:CONTInuous is set to ON, the 4240 immediately begins taking measurements. If set to OFF, the measurement will begin as soon as the INITiate command is issued, and will stop once the measurement criteria (averaging, filtering or sample count) has been satisfied. Note that INITiate:IMMEDIATE and READ commands are invalid when INITiate:CONTInuous is set to ON; however, by convention this situation does not result in a SCPI error.

Syntax: INITiate:CONTInuous <Boolean>

Argument: <Boolean> = { 0, 1, OFF, ON }

### INITiate[:IMMEDIATE[:ALL]]

Description: Starts a single measurement cycle when INITiate:CONTInuous is set to OFF. The measurement will complete once the power has been integrated for the full FILTER time. No reading will be returned until the measurement is complete. This command is not valid when INITiate:CONTInuous is ON, however, by convention this situation does not result in a SCPI error.

Syntax: INITiate[:IMMEDIATE[:ALL]]

Argument: None

Restrictions: INITiate:CONTInuous must be OFF

# Boonton 4240 Series RF Power Meter

## 5.5.7 MEASure Queries

The MEASure group of commands is used to acquire data using a set of high level instructions. They are structured to allow the user to trade off fine control of the measurement process for easy operability. MEASure? provides a complete capability where the power meter is configured, a measurement taken, and results returned in one operation. The instrument is set to a basic, predefined measurement state with little user intervention necessary or possible. Sometimes, more precise control of measurement is required. In these cases, MEASure? should not be used. Rather, a sequence of configuration commands, generally from the CALCulate and SENSE groups should be used to set up the instrument for the measurement, then READ? or FETCH? commands are used to return the desired measurement data in a specific format.

### MEASure:POWer?

Description: Return a power measurement in dBm using a default instrument configuration. The instrument remains stopped after a measurement.

Syntax: Measure[1|2]:POWer?

Returns: CC, Power in dBm  
Where CC is the measurement condition code.

### MEASure:VOLTagE?

Description: Return average voltage using a default instrument configuration in volts units. Instrument remains stopped after a measurement.

Syntax: MEASure[1|2]:VOLTagE?

Returns: CC, Average voltage in linear volts  
Where CC is the measurement condition code.

# Boonton 4240 Series RF Power Meter

## 5.5.8 MEMory Subsystem

The MEMory group of commands is used to save and recall instrument operating configurations, and to edit and review user-supplied frequency dependent offset (FDOF) tables for external devices in the signal path. Up to ten configurations may be saved, and two frequency dependent offset tables. Note, however that assigning a stored FDOF table to a particular measurement channel is not a MEMory command; it is handled through the SENSE subsystem.

### MEMory:SNSR:CF?

Description: Return the sensor frequency cal-factor table.  
Syntax: MEMory:SNSR[1|2]:CF?  
Argument: None, query only.

### MEMory:SNSR:CWRG?

Description: Return sensor AC cal data.  
Syntax: MEMory:SNSR[1|2]:CWRG?  
Argument: None, query only.

### MEMory:SNSR:INFO?

Description: Return the sensor ID and parameter data.  
Syntax: MEMory:SNSR[1|2]:INFO?  
Argument: None

### MEMory:SYS:LOAD

Description: Recall a previously stored configuration of an instrument setup.  
Syntax: MEMory:SYS:LOAD <filename>  
Argument: Alphanumeric filename, "USER0" thru "USER10"

### MEMory:SYS:STORe

Description: Save the configuration of the current instrument setup.  
Syntax: MEMory:SYS:STORe <filename>  
Argument: Alphanumeric filename, "USER1" thru "USER10"



# Boonton 4240 Series RF Power Meter

## 5.5.9 OUTPut Subsystem

The OUTPut group of commands is used to control various outputs of the 4240. These outputs include the internal 50 MHz calibrator and the Recorder Output. The internal 50 MHz calibrator is primarily used for automatic calibration of power sensors. Precise level continuous wave (CW) signals can also be sourced by the internal calibrator. OUTPut commands for the Recorder Output include setting the DC output to the MAXimum or MINimum level or can be forced to any level in between. Also the Recorder Output can be assigned to either channel 1 or 2.

### OUTPut:LEVel[:POWer]

Description: Set or return the power level of the internal 50 MHz calibrator output signal.  
Syntax: OUTPut:LEVel[:POWer ]< numeric value >  
Argument: < numeric value > = -60.0 to +20.0 dBm (0.1dB resolution)

### OUTPut:SIGNAL

Description: Set or return the on/off state of the internal 50 MHz output signal.  
Syntax: OUTPut:SIGNAL <Boolean>  
Argument: <Boolean> = { 0, 1, OFF, ON }

### OUTPut:RECOOrder:FORCe

Description: Command sets the output voltage to the argument. Query returns the output voltage previously set by FORCe or causes error -221 "Settings conflict" if the Recorder Ouput has been assigned to a channel.  
Syntax: OUTPut:RECOOrder:FORCe <numeric value>  
Argument: <numeric value> = 0.000 to + 10.000 V

### OUTPut:RECOOrder:MAX

Description: Set or return the recorder output maximum, or full scale (+10.0V) power reference level.  
Syntax: OUTPut:RECOOrder:MAX  
Argument: none

### OUTPut:RECOOrder:MIN

Description: Set or return the recorder output minimum, or downscale (0.0V) power reference level.  
Syntax: OUTPut:RECOOrder:MIN  
Argument: none

# Boonton 4240 Series RF Power Meter

## **OUTPut:RECOOrder:SOURce**

Description: Set or return the source channel for the Recorder Output.

Syntax: **OUTPut:RECOOrder:SOURce** <character data>

Argument: <character data> = CH1, CH2, ACTIVE

# Boonton 4240 Series RF Power Meter

## 5.5.10 READ Queries

The purpose of the READ? group of queries is to initiate a measurement cycle, acquire data, and return specific measurement data. READ? performs the initiation, data acquisition, postprocessing, and data output portions of the measurement. READ? is equivalent to ABORting any operation in progress, INITiating a new measurement, then FETChing the data when it is ready. READ? generally does not return data unless acquisition is complete. Since READ? INITiates a new measurement every time it is issued, READ? queries should not be used for free running data acquisition (INITiate:CONTinuous ON) - in this case, use FETCh queries instead. The measurement is generally considered complete when the integration filter (see SENSE:FILTer) is filled.

### READ: CW: POWER?

Description: Return current average amplitude reading in channel units.  
Syntax: READ[1|2]:CW:POWER?  
Returns: CC, Average power (watts, dBm)  
Where CC is the measurement condition code.

# Boonton 4240 Series RF Power Meter

## 5.5.11 SENSE subsystem

The purpose of the SENSE command subsystem is to directly configure device specific settings used to make measurements, generally parameters related to the RF power sensor and signal processing. The SENSE commands are used to configure the power meter for acquiring data. SENSE enables you to change measurement parameters such as filtering or averaging, operating frequency and calfactors, and measurement gain or offset. The numeric suffix of the SENSE program mnemonic in the SENSE commands refers to a hardware measurement “channel”, that is SENSE1 and SENSE2 represent the instrument’s SENSOR 1 and SENSOR 2 signal paths, respectively. The SENSE commands generally DO NOT affect the data processing and display portion of the measurement (see the CALCulate subsystem, Section 5.5.2). Note that SENSE2 commands will generate an error if used with a single channel 4240 Series instrument.

### SENSE:CORRection:CALFactor

- Description: Set or return the frequency calfactor currently in use on the selected channel. Note setting a calfactor with this command will override the “automatic” frequency calfactor that was calculated and applied when the operating frequency was set, and setting the operating frequency will override this calfactor setting.
- Syntax: SENSE[1|2]:CORRection:CALFactor <numeric value>
- Argument: <numeric value> = -3.00 to 3.00 dB

### SENSE:CORRection:DCYClE

- Description: Set or return the duty cycle correction factor currently in use on the selected channel.
- Syntax: SENSE[1|2]:CORRection:DCYClE
- Argument: <numeric value> = 0.01 to 100.00 percent

### SENSE:CORRection:FREQuency

- Description: Set or return the RF frequency for the current sensor, and apply the appropriate frequency calfactor from the sensor’s EEPROM table. Application of this calfactor cancels out the effect of variations in the flatness of the sensor’s frequency response. If an explicit calfactor has been set, either manually or via the SENSE:CORRection:CALFactor command, entering a new frequency will override this calfactor and use only the “automatic” frequency calfactor.
- Syntax: SENSE[1|2]:CORRection:FREQuency <numeric value>
- Argument: <numeric value> = 0.01e9 to 110.0e9 Hz (actual sensor may have narrower range)

### SENSE:CORRection:OFFSet

- Description: Set or return a measurement offset in dB for the selected sensor. This is used to compensate for external couplers, attenuators or amplifiers in the RF signal path ahead of the power sensor.
- Syntax: SENSE[1|2]:CORRection:OFFSet <numeric value>
- Argument: <numeric value> = -99.99 to 99.99 dB

# Boonton 4240 Series RF Power Meter

## **SENSe:FILTer:STATe**

- Description: Set or return the current setting of the integration filter on the selected channel. OFF provides no filtering, and can be used at high signal levels when absolute minimum settling time is required. ON allows a user-specified integration time, from 50 milliseconds to 20 seconds (see **SENSe:FILTer:TIME** command). Note that setting the filter time will force the state to ON. AUTO uses a variable amount of filtering, which is set automatically by the power meter based on the current signal level to a value that gives a good compromise between measurement noise and settling time at most levels.
- Syntax: **SENSe[1|2]:FILTer:STATe <character data>**
- Argument: <character data> = {OFF, ON, AUTO}

## **SENSe:FILTer:TIME**

- Description: Set or return the current length of the integration filter on the selected channel. If the filter state is set to AUTO, querying the time will return -0.01, and if set to OFF, a time query will return 0.00. Note that setting the filter time will force the state to ON.
- Syntax: **SENSe[1|2]:FILTer:TIME <numeric value>**
- Argument: <numeric value> = 0.05 to 20.00 seconds in 50 millisecond increments

# Boonton 4240 Series RF Power Meter

## 5.5.12 STATus Commands

The STATus command subsystem enables you to control the SCPI defined status reporting structures. The user may examine the status or control status reporting of the power meter by accessing the Device, Operation and Questionable status groups.

### STATus:DEVIce:CONDition?

Description: Return the current value of the Device Condition register. The following table shows the bit assignments in the register. These bits are updated by the instrument in real time, and can change in response to changes in the instrument's operating condition.

| <u>Bit</u> | <u>Value</u> | <u>Definition</u>   |                                                  |
|------------|--------------|---------------------|--------------------------------------------------|
| 0          | 1            | Not used            | always returns 0.                                |
| 1          | 2            | Channel 1 Connected | 1 = A sensor or probe is connected to channel 1. |
| 2          | 4            | Channel 2 Connected | 1 = A sensor or probe is connected to channel 2. |
| 3          | 8            | Channel 1 Error     | 1 = Channel 1 is reporting an error.             |
| 4          | 16           | Channel 2 Error     | 1 = Channel 2 is reporting an error.             |
| 5          | 32           | Shape Cal 1         | 1 = Channel 1 is using a CW shape cal table.     |
| 6          | 64           | Shape Cal 2         | 1 = Channel 2 is using a CW shape cal table.     |
| 7          | 128          | Smart Cal 1         | 1 = Channel 1 is using a CW smart cal table.     |
| 8          | 256          | Smart Cal 2         | 1 = Channel 2 is using a CW smart cal table.     |
| 9          | 512          | Auto Cal 1          | 1 = Channel 1 is using an auto cal table.        |
| 10         | 1024         | Auto Cal 2          | 1 = Channel 2 is using an auto cal table.        |
| 11         | 2048         | Not used            | always returns 0.                                |
| 12         | 4096         | Not used            | always returns 0.                                |
| 13         | 8192         | Key Press           | 1 = A key has been pressed.                      |
| 14         | 16384        | Not used            | always returns 0.                                |
| 15         | 32768        | Not used            | always returns 0.                                |

Syntax: STATus:DEVIce:CONDition?

Returns: 16-bit register value (0 to 65535)

### STATus:DEVIce:ENABle

Description: Sets or returns the Device Enable register, which contains the bit mask that defines which true conditions in the Device Status Event register will be reported in the Device Summary bit of the instrument Status Byte. If any bit is 1 in the Device Enable register and its corresponding Device Event bit is true, the Device Status summary bit will be set.

Syntax: STATus:DEVIce:ENABle <numeric value>

Argument: <numeric value> = 0 to 65535

Returns: 16-bit register value (0 to 65535)

## Boonton 4240 Series RF Power Meter

### **STATus:DEvice:EVENT?**

Description: Returns the current contents of the Device Event register then resets the register value to 0. The Device Event register contains the latched events from the Device Condition register as specified by the Device status group's positive and negative transition filters.

Syntax: STATus:DEvice:EVENT?

Returns: 16-bit register value (0 to 65535)

### **STATus:DEvice:NTRansition**

Description: Set or return the value of the negative transition filter bitmask for the Device status group. Setting a bit in the negative transition filter causes a 1 to 0 (negative) transition in the corresponding bit of the Device Condition register to cause a 1 to be written in the associated bit of the Device Event register.

Syntax: STATus:DEvice:NTRansition <numeric value>

Argument: <numeric value> = 0 to 65535

Returns: 16-bit register value (0 to 65535)

### **STATus:DEvice:PTRansition**

Description: Set or return the value of the positive transition filter bitmask for the Device status group. Setting a bit in the positive transition filter causes a 0 to 1 (positive) transition in the corresponding bit of the Device Condition register to cause a 1 to be written in the associated bit of the Device Event register.

Syntax: STATus:DEvice:PTRansition <numeric value>

Argument: <numeric value> = 0 to 65535

Returns: 16-bit register value (0 to 65535)

# Boonton 4240 Series RF Power Meter

## STATus:OPERation:CONDition?

Description: Return the current value of the Operation Condition register. The following table shows the bit assignments in the register. These bits are updated by the instrument in real time, and can change in response to changes in the instrument's operating condition.

| Bit | Value | Definition    |                                                 |
|-----|-------|---------------|-------------------------------------------------|
| 0   | 1     | Calibrating   | 1 = sensor calibration in progress.             |
| 1   | 2     | Settling      | 1 = averaging filter is not full.               |
| 2   | 4     | Ranging       | 1 = range change in progress.                   |
| 3   | 8     | Not used      | always returns 0.                               |
| 4   | 16    | Measuring     | 1 = measurement in progress.                    |
| 5   | 32    | Triggering    | 1 = Trigger mode enabled waiting for a trigger. |
| 6   | 64    | Not used      | always returns 0.                               |
| 7   | 128   | Not used      | always returns 0.                               |
| 8   | 256   | Alarm 1       | 1 = Channel 1 is in an alarm condition.         |
| 9   | 512   | Alarm 2       | 1 = Channel 2 is in an alarm condition.         |
| 10  | 1024  | Alarm Latch 1 | 1 = Channel 1 alarm is latched.                 |
| 11  | 2048  | Alarm Latch 2 | 1 = Channel 2 alarm is latched.                 |
| 12  | 4096  | Not used      | always returns 0                                |
| 13  | 8192  | Not used      | always returns 0.                               |
| 14  | 16384 | Not used      | always returns 0.                               |
| 15  | 32768 | Not used      | always returns 0.                               |

Syntax: STATus:OPERation:CONDition?

Returns: 16-bit register value (0 to 65535)

## STATus:OPERation:ENABLE

Description: Sets or returns the Operation Enable register, which contains the bit mask that defines which true conditions in the Operation Status Event register will be reported in the Operation Summary bit of the instrument Status Byte. If any bit is 1 in the Operation Enable register and its corresponding Operation Event bit is true, the Operation Status summary bit will be set.

Syntax: STATus:OPERation:ENABLE <numeric value>

Argument: <numeric value> = 0 to 65535

Returns: 16-bit register value (0 to 65535)

## STATus:OPERation:EVENT?

Description: Returns the current contents of the Operation Event register then resets the register value to 0. The Operation Event register contains the latched events from the Operation Condition register as specified by the Operation status group's positive and negative transition filters.

Syntax: STATus:OPERation:EVENT?

Returns: 16-bit register value (0 to 65535)



# Boonton 4240 Series RF Power Meter

## **STATus:OPERation:NTRansition**

Description: Set or return the value of the negative transition filter bitmask for the Operation status group. Setting a bit in the negative transition filter causes a 1 to 0 (negative) transition in the corresponding bit of the Operation Condition register to cause a 1 to be written in the associated bit of the Operation Event register.

Syntax: STATus:OPERation:NTRansition <numeric value>

Argument: <numeric value> = 0 to 65535

Returns: 16-bit register value (0 to 65535)

## **STATus:OPERation:PTRansition**

Description: Set or return the value of the positive transition filter bitmask for the Operation status group. Setting a bit in the positive transition filter causes a 0 to 1 (positive) transition in the corresponding bit of the Operation Condition register to cause a 1 to be written in the associated bit of the Operation Event register.

Syntax: STATus:OPERation:PTRansition <numeric value>

Argument: <numeric value> = 0 to 65535

Returns: 16-bit register value (0 to 65535)

## **STATus:PRESet**

Description: Sets SCPI enable registers and transition filters to the default state. The Operational Enable and Questionable Enable mask registers are both cleared so an SRQ will not be generated for these conditions. All bits for the device and questionable calibration registers are enabled. All positive transition filters are enabled and all negative transition filters are cleared.

Syntax: STATus:PRESet

Argument: None

# Boonton 4240 Series RF Power Meter

## STATus:QUEStionable:CONDition?

Description: Return the current value of the Questionable Condition register. The following table shows the bit assignments in the register. These bits are updated by the instrument in real time, and can change in response to changes in the instrument's operating condition.

| Bit | Value | Definition  |                                                |
|-----|-------|-------------|------------------------------------------------|
| 0   | 1     | Not used    | always 0.                                      |
| 1   | 2     | Not used    | always 0.                                      |
| 2   | 4     | Not used    | always 0.                                      |
| 3   | 8     | Power       | 1 = a power measurement may be invalid.        |
| 4   | 16    | Not used    | always 0.                                      |
| 5   | 32    | Not used    | always 0.                                      |
| 6   | 64    | Not used    | always 0.                                      |
| 7   | 128   | Not used    | always 0.                                      |
| 8   | 256   | Calibration | 1 = sensor requires calibration and/or zeroing |
| 9   | 512   | Not used    | always 0.                                      |
| 10  | 1024  | Not used    | always 0.                                      |
| 11  | 2048  | Not used    | always 0.                                      |
| 12  | 4096  | Not used    | always 0.                                      |
| 13  | 8192  | Not used    | always 0.                                      |
| 14  | 16384 | Not used    | always 0.                                      |
| 15  | 32768 | Not used    | always 0.                                      |

Syntax: STATus:QUEStionable:CONDition?

Returns: 16-bit register value (0 to 65535)

## STATus:QUEStionable:ENABLE

Description: Sets or returns the Questionable Enable register, which contains the bit mask that defines which true conditions in the Questionable Status Event register will be reported in the Questionable Summary bit of the instrument Status Byte. If any bit is 1 in the Questionable Enable register and its corresponding Questionable Event bit is true, the Questionable Status summary bit will be set.

Syntax: STATus:QUEStionable:ENABLE <numeric value>

Argument: <numeric value> = 0 to 65535

Returns: 16-bit register value (0 to 65535)

## STATus:QUEStionable:EVENT?

Description: Returns the current contents of the Questionable Event register then resets the register value to 0. The Questionable Event register contains the latched events from the Questionable Condition register as specified by the Questionable status group's positive and negative transition filters.

Syntax: STATus:QUEStionable:EVENT?

Returns: 16-bit register value (0 to 65535)

# Boonton 4240 Series RF Power Meter

## **STATus:QUEStionable:NTRansition**

Description: Set or return the value of the negative transition filter bit mask for the Questionable status group. Setting a bit in the negative transition filter causes a 1 to 0 (negative) transition in the corresponding bit of the Questionable Condition register to cause a 1 to be written in the associated bit of the Questionable Event register.

Syntax: **STATus:QUEStionable:NTRansition** <numeric value>

Argument: <numeric value> = 0 to 65535

Returns: 16-bit register value (0 to 65535)

## **STATus:QUEStionable:PTRansition**

Description: Set or return the value of the positive transition filter bit mask for the Questionable status group. Setting a bit in the positive transition filter causes a 0 to 1 (positive) transition in the corresponding bit of the Questionable Condition register to cause a 1 to be written in the associated bit of the Questionable Event register.

Syntax: **STATus:QUEStionable:PTRansition** <numeric value>

Argument: <numeric value> = 0 to 65535

Returns: 16-bit register value (0 to 65535)

## **STATus:QUEStionable:CALibration:CONDition?**

Description: Return the current value of the Questionable Calibration Condition register. This register is used to notify the user of questionable quality with respect to calibration. The following table shows the bit assignments in the register. These bits are updated by the instrument in real time, and can change in response to changes in the instrument's operating condition.

| <u>Bit</u> | <u>Value</u> | <u>Definition</u>                                               |
|------------|--------------|-----------------------------------------------------------------|
| 0          | 1            | Not Used                                                        |
| 1          | 2            | Not used                                                        |
| 2          | 4            | Sens1 Default Shape    1 = Channel 1 using default shape table. |
| 3          | 8            | Sens2 Default Shape    1 = Channel 2 using default shape table. |

Syntax: **STATus:QUEStionable:CALibration:CONDition?**

Returns: 16-bit register value (0 to 65535)

# Boonton 4240 Series RF Power Meter

## **STATus:QUEStionable:CALibration:ENABle**

Description: Sets or returns the Questionable Calibration Enable register, which contains the bit mask that defines which true conditions in the Questionable Calibration Event register will be reported in the Questionable Calibration Summary bit of the Questionable Condition register. If any bit is 1 in the Questionable Calibration Enable register and its corresponding Questionable Calibration Event bit is true, the Questionable Calibration summary bit will be set.

Syntax: **STATus:QUEStionable:CALibration:ENABle** <numeric value>

Argument: <numeric value> = 0 to 65535

Returns: 16-bit register value (0 to 65535)

## **STATus:QUEStionable:CALibration:EVENT?**

Description: Returns the current contents of the Questionable Calibration Event register then resets the register value to 0. The Questionable Calibration Event register contains the latched events from the Questionable Calibration Condition register as specified by the Questionable Calibration status group's positive and negative transition filters.

Syntax: **STATus:QUEStionable:CALibration:EVENT?**

Returns: 16-bit register value (0 to 65535)

## **STATus:QUEStionable:CALibration:NTRansition**

Description: Set or return the value of the negative transition filter bit mask for the Questionable Calibration status group. Setting a bit in the negative transition filter causes a 1 to 0 (negative) transition in the corresponding bit of the Questionable Calibration Condition register to cause a 1 to be written in the associated bit of the Questionable Calibration Event register.

Syntax: **STATus:QUEStionable:CALibration:NTRansition** <numeric value>

Argument: <numeric value> = 0 to 65535

Returns: 16-bit register value (0 to 65535)

## **STATus:QUEStionable:CALibration:PTRansition**

Description: Set or return the value of the positive transition filter bit mask for the Questionable Calibration status group. Setting a bit in the positive transition filter causes a 0 to 1 (positive) transition in the corresponding bit of the Questionable Calibration Condition register to cause a 1 to be written in the associated bit of the Questionable Calibration Event register.

Syntax: **STATus:QUEStionable:CALibration:PTRansition** <numeric value>

Argument: <numeric value> = 0 to 65535

Returns: 16-bit register value (0 to 65535)

# Boonton 4240 Series RF Power Meter

## 5.5.13 SYSTem Subsystem

The SYSTem group of commands is used to control system-level functions not directly related to instrument measurement performance. SYSTem commands are used to return error codes or messages from the power meter error queue, control hardware features and configure communication parameters for the GPIB.

### **SYSTem:BEEP[:ENABle]**

Description: Set or return the status of the audible keyboard beeper.  
Syntax: SYSTem:BEEP[:ENABle] <Boolean>  
Argument: <Boolean> = { 0, 1, OFF, ON }

### **SYSTem:BEEP:IMMediate**

Description: Causes the system to emit an audible beep. Command only; does not respond to a query.  
Syntax: SYSTem:BEEP:IMMediate  
Argument: None

### **SYSTem:COMMunicate:GPIB:ADDRess**

Description: Set or return the GPIB bus address.  
Syntax: SYSTem:COMMunicate:GPIB:ADDRess <numeric value>  
Argument: <numeric value> = 1 to 30

### **SYSTem:COMMunicate:GPIB:EOI**

Description: Set or return the status of the GPIB EOI .  
Syntax: SYSTem:COMMunicate:GPIB:EOI <Boolean>  
Argument: <Boolean> = { 0, 1, OFF, ON }

### **SYSTem:COMMunicate:GPIB:LISTen**

Description: Set or return the GPIB Listen end-of-string terminator .  
Syntax: SYSTem:COMMunicate:GPIB:LISTen <character data>  
Argument: <character data> = {LF, CR, CRLF, EOIONLY}

# Boonton 4240 Series RF Power Meter

## **SYSTem:COMMunicate:GPIB:TALK**

Description: Set or return the GPIB Talk end-of-string terminator .  
Syntax: SYSTem:COMMunicate:GPIB:TALK <character data>  
Argument: <character data> = {LF, CR, CRLF, EOIONLY}

## **SYSTem:COMMunicate:SERial:BAUD**

Description: Set or return the RS232 baud rate.  
Syntax: SYSTem:COMMunicate:SERial:BAUD <numeric value>  
Argument: <numeric value> = 300, 600, 1200, 2400, 4800, 9600, 19200, 38400, 57600, 115200

## **SYSTem:COMMunicate:SERial:BITS**

Description: Set or return the RS232 serial word length (Data Bits).  
Syntax: SYSTem:COMMunicate:SERial:BITS <numeric value>  
Argument: <numeric value> = 7, 8

## **SYSTem:COMMunicate:SERial:PARity**

Description: Set or return the RS232 parity.  
Syntax: SYSTem:COMMunicate:SERial:PARity < character data >  
Argument: <character data> = ODD, EVEN, NONE

## **SYSTem:COMMunicate:SERial:SBITS**

Description: Set or return the number of RS232 serial stop bits.  
Syntax: SYSTem:COMMunicate:SERial:SBITS <numeric value>  
Argument: <numeric value> = 1, 2

# Boonton 4240 Series RF Power Meter

## **SYSTem:ERRor[:NEXT]?**

Description: Returns the next queued error code number followed by a quoted ASCII text string describing the error. Note that errors are stored in a “first-in-first-out” queue, so if more than one error has occurred, repeating this command will report the errors in the sequence they happened. The action of reading an error removes that error from the queue, so once the most recent error has been read, further queries will report a code of zero, and “No Error”. See Appendix A for detailed descriptions of the error codes that may be returned.

Syntax: **SYSTem:ERRor[:NEXT]?**

Returns: <numeric error code>, “QUOTED ERROR DESCRIPTION”

## **SYSTem:ERRor:CODE?**

Description: Returns the next queued error code number. Note that errors are stored in a “first-in-first-out” queue, so if more than one error has occurred, repeating this command will report the error codes in the sequence they happened. The action of reading an error removes that error from the queue, so once the most recent error has been read, any more queries will report a code of zero. See Appendix A for a more detailed description of the error codes that may be returned.

Syntax: **SYSTem:ERRor:CODE?**

Returns: <numeric error code>

## **SYSTem:ERRor:COUNt?**

Description: Returns the number of errors that currently exist in the error queue. A value of 0 means that there are no errors in the queue. Therefore, either no errors have occurred, or all errors have been read. See Appendix A for a more detailed description of the error codes that may be returned.

Syntax: **SYSTem:ERRor:COUNt?**

Returns: <numeric error code>

## **SYSTem:PRESet**

Description: Set 4240 default parameters. Equivalent to SETUP > RECALL > DEFAULT. See Tables 3-2, 3-3 and 3-4 for a list of the default values for each parameter.

Syntax: **SYSTem:PRESet**

Argument: None

## **SYSTem:VERSion?**

Description: Return the SCPI version compliance claimed.

Syntax: **SYSTem:VERSion?**

Returns: <character data> = Version Code as <year.version> YYYY.V (will return 1999.0)

# Boonton 4240 Series RF Power Meter

## 5.5.14 INSTRument:VERSion Commands

INSTRument:VERSion group of commands is used to query the firmware and FPGA revision codes. The firmware code follows a “YYYYMMDD” format. The FPGA revision format has a major and minor representation in the form of “MM.mm” where “MM” is the major revision number and “mm” in the minor revision number.

### INSTRument:VERSion:FIRMware?

Description: Returns the firmware revision code.  
Syntax: INSTRument:VERSion:FIRMware?  
Returns: YYYYMMDD

### INSTRument:VERSion:FPGA?

Description: Returns the FPGA revision code.  
Syntax: INSTRument:VERSion:FPGA?  
Returns: MM.mm



# Boonton 4240 Series RF Power Meter

## 5.5.15 SCPI Command Summary

**Table 5-1. SCPI COMMAND SUMMARY**

---

|                                        |                                                                                               |
|----------------------------------------|-----------------------------------------------------------------------------------------------|
| *CLS                                   | Clear Status Command                                                                          |
| *ESE                                   | Set/get Standard Event Status Enable                                                          |
| *ESR?                                  | Standard Event Status Register Query                                                          |
| *IDN                                   | Identification Query                                                                          |
| *OPC                                   | Operation Complete Command                                                                    |
| *OPC?                                  | Operation Complete Query                                                                      |
| *OPT?                                  | Return the instrument options                                                                 |
| *RST                                   | Reset Command                                                                                 |
| *SRE                                   | Set/get Service Request Enable                                                                |
| *STB?                                  | Read Status Byte Query                                                                        |
| *TRG                                   | Simulate Group Execute Trigger                                                                |
| *TST?                                  | Self-Test Query                                                                               |
| ABORT                                  | Immediately set measurement trigger system to idle                                            |
| CALCulate[1 2]:LIMit:CLEar[:IMMediate] | Clear all latched limit alarms                                                                |
| CALCulate[1 2]:LIMit:FAIL?             | Return the status of all alarms.<br><Boolean> = {summary, LL, UL, LLL, ULL}                   |
| CALCulate[1 2]:LIMit:LOWer[:POWer]     | Set/return lower limit power level.<br>< numeric value > = -99.99 to +99.99 dBm               |
| CALCulate[1 2]:LIMit[:BOTH]:STATe      | Set or return the combined upper and lower limit alarm system state for the selected channel. |
| CALCulate[1 2]:LIMit:LOWer:STATe       | Set/return lower limit alarms. <Boolean> = 0, 1, OFF, ON                                      |
| CALCulate[1 2]:LIMit:UPPer:STATe       | Set/return upper limit alarms. <Boolean> = 0, 1, OFF, ON                                      |
| CALCulate[1 2]:LIMit:UPPer[:POWer]     | Set/return upper limit power level.<br>< numeric value > = -99.99 to +99.99 dBm               |
| CALCulate:MATH:ARGA                    | Set or return the first argument to be used for channel math operations.                      |

# Boonton 4240 Series RF Power Meter

## Table 5-1. SCPI COMMAND SUMMARY (continued)

|                                  |                                                                                                                                                         |
|----------------------------------|---------------------------------------------------------------------------------------------------------------------------------------------------------|
| CALCulate:MATH:ARGB              | Set or return the second argument to be used for channel math operations.                                                                               |
| CALCulate:MATH:DATA?             | Returns the channel math result.                                                                                                                        |
| CALCulate:MATH:OPERator          | Set or return the channel math operator.                                                                                                                |
| CALCulate:MODE                   | Set/return remote measurement mode<br><character data> = NORMAl, FAST, FILTEred                                                                         |
| CALCulate[1 2]:REFErence:COLLect | Set the current reading to be the ratiometric measurement reference level.                                                                              |
| CALCulate[1 2]:REFErence:DATA    | Set or return the ratiometric measurement reference level in dBm.<br><numeric value> = -99.99 to +99.99 dBm                                             |
| CALCulate[1 2]:REFErence:STATe   | Set or return the ratiometric measurement mode state.<br><Boolean> = 0, 1, OFF, ON                                                                      |
| CALCulate[1 2]:STATe             | Enable currently selected channel allowing measurements to be made. <Boolean> = 0, 1, OFF, ON                                                           |
| CALCulate[1 2]:UNITs             | Change channel units. <character value> = DBM, Watts, Volts, DBV, DBMV, DBUV                                                                            |
| CALibration[1 2]:AUTOcal         | Start auto calibration with internal calibrator.                                                                                                        |
| CALibration[1 2]:FIXedcal        | Start fixed calibration with internal calibrator.                                                                                                       |
| CALibration[1 2]:ZERO            | Start zero process.                                                                                                                                     |
| DISPlay:ACTive                   | Set/return the active channel for talk commands.                                                                                                        |
| DISPlay:CLEar                    | Clear measurement data and display.                                                                                                                     |
| DISPlay:LIN:RESolution           | Set number of significant digits for linear displays and remote return values. <numeric value> = 3 to 5                                                 |
| DISPlay:LOG:RESolution           | Set number of decimal places for log displays and remote return values. <numeric value> = 1 to 3                                                        |
| DISPlay:LABel:MODE               | Enables/disables the user message display.<br><Boolean> = 0, 1, OFF, ON                                                                                 |
| DISPlay:Label:TEXTA              | Displays a text message in the first label field.<br><alphanumeric value> = A to Z, a to z, 0 to 9 ! @ # \$ % ^ & *<br>( ) _ - + = { } [ ] ? / < > : .  |
| DISPlay:Label:TEXTB              | Displays a text message in the second label field.<br><alphanumeric value> = A to Z, a to z, 0 to 9 ! @ # \$ % ^ & *<br>( ) _ - + = { } [ ] ? / < > : . |

# Boonton 4240 Series RF Power Meter

**Table 5-1. SCPI COMMAND SUMMARY (continued)**

|                            |                                                                                                                                                  |
|----------------------------|--------------------------------------------------------------------------------------------------------------------------------------------------|
| DISPlay:Label:TEXTC        | Displays a text message in the third label field.<br><alphanumeric value> = A to Z, a to z, 0 to 9 !@#\$%^&*<br>( ) _ - + = { } [ ] ? / < > : .  |
| DISPlay:Label:TEXTD        | Displays a text message in the fourth label field.<br><alphanumeric value> = A to Z, a to z, 0 to 9 !@#\$%^&*<br>( ) _ - + = { } [ ] ? / < > : . |
| FETCh[1 2]:CW:POWer?       | Return current average reading in power units                                                                                                    |
| FETCh:KEY?                 | Return code of last key depressed                                                                                                                |
| INITiate:CONTinuous        | Set/return state of mode which triggers meas cycles continuously.<br><Boolean> = 0, 1, OFF, ON                                                   |
| INITiate[:IMMediate[:ALL]] | Set mode which starts a measurement cycle when trigger event occurs                                                                              |
| MEASure[1 2]:POWer?        | Return the average power measurement in dBm                                                                                                      |
| MEASure[1 2]:VOLTagE?      | Return the average power measurement in equivalent volts.                                                                                        |
| MEMory[1 2]:SNSR:CF?       | Return the sensor frequency cal-factor table.                                                                                                    |
| MEMory[1 2]:SNSR:CWRG?     | Return sensor AC cal data.                                                                                                                       |
| MEMory[1 2]:SNSR:INFO?     | Return the sensor ID and parameter data.                                                                                                         |
| MEMory:SYST:LOAD           | Load saved instrument setup by filename.<br><character data> = "USER0" ... "USER10".                                                             |
| MEMory:SYST:STORe          | Save instrument setup by filename.<br><character data> = "USER1" ... "USER10".                                                                   |
| OUTPut:LEVel[:POWer]       | Set or return the power level of the internal 50 MHz calibrator output signal.                                                                   |
| OUTPut:SIGNal              | Set or return the on/off state of the internal 50 MHz output signal.                                                                             |
| OUTPut:RECOOrder:FORCe     | Command sets the Recorder Output voltage to the argument.<br><numeric value> = 0.0 to + 10.0 V                                                   |
| OUTPut:RECOOrder:MAX       | Set or return the Recorder Output maximum, or full scale (+10.0V) power reference level.                                                         |
| OUTPut:RECOOrder:MIN       | Set or return the Recorder Output minimum, or downscale (0.0V) power reference level                                                             |
| OUTPut:RECOOrder:SOURce    | Set or return the source channel for the Recorder Output.<br><character data> = CH1, CH2, ACTIVE                                                 |
| READ[1 2]:CW:POWer?        | Return new average reading in power units.                                                                                                       |

# Boonton 4240 Series RF Power Meter

## 5-1. SCPI COMMAND SUMMARY (continued)

---

|                                            |                                                                                                                             |
|--------------------------------------------|-----------------------------------------------------------------------------------------------------------------------------|
| SENSe[1 2]:CORRection:CALFactor            | Set correction factor in dB.<br><numeric value> = -3.00 to 3.00                                                             |
| SENSe[1 2]:CORRection:DCYClE               | Set/return duty cycle correction factor in percent.<br><numeric value> = 0.0 to 100.0%                                      |
| SENSe[1 2]:CORRection:FREQuency            | Set channel frequency.<br><numeric value> = 0.01e9 to 110.00e9 Hz                                                           |
| SENSe[1 2]:CORRection:OFFSet               | Set/return sensor offset value in dB.<br><numeric value> = -99.99 to 99.99                                                  |
| SENSe[1 2]:FILTer:STATe                    | Set/return filter state.<br><character data> = OFF, AUTO, ON                                                                |
| SENSe[1 2]:FILTer:TIME                     | Set or return the current length of the integration filter on the selected channel. <numeric value> = 0.05 to 20.00 seconds |
| STATus:DEVice:CONDition?                   | Return value of Device Condition Register                                                                                   |
| STATus:DEVice:ENABle                       | Set/return value of Device Enable Mask                                                                                      |
| STATus:DEVice:EVENt?                       | Return value of Device Event Register                                                                                       |
| STATus:DEVice:NTRansiion                   | Set/return the Negative Transition filter                                                                                   |
| STATus:DEVice:PTRansiion                   | Set/return the Positive Transition filter                                                                                   |
| STATus:OPERation:CONDition?                | Return value of Operation Condition Register                                                                                |
| STATus:OPERation:ENABle                    | Set/return value of Operation Enable Mask                                                                                   |
| STATus:OPERation:EVENt?                    | Return value of Operation Event Register                                                                                    |
| STATus:OPERation:NTRansiion                | Set/return the Negative Transition filter                                                                                   |
| STATus:OPERation:PTRansiion                | Set/return the Positive Transition filter                                                                                   |
| STATus:PRESet                              | Set device dependent SCPI registers to default states                                                                       |
| STATus:QUEStionable:CONDition?             | Return value of Questionable Condition Register                                                                             |
| STATus:QUEStionable:ENABle                 | Set/return value of Questionable Enable Mask                                                                                |
| STATus:QUEStionable:EVENt?                 | Return value of Questionable Event Register                                                                                 |
| STATus:QUEStionable:NTRansiion             | Set/return the negative transition filter                                                                                   |
| STATus:QUEStionable:PTRansiion             | Set/return the positive transition filter                                                                                   |
| STATus:QUEStionable:CALibration:CONDition? | Return value of the questionable calibration condition register                                                             |
| STATus:QUEStionable:CALibration:ENABle     | Set/return value of the questionable calibration enable mask                                                                |

# Boonton 4240 Series RF Power Meter

**Table 5-1. SCPI COMMAND SUMMARY (continued)**

---

|                                             |                                                                                                                    |
|---------------------------------------------|--------------------------------------------------------------------------------------------------------------------|
| STATus:QUEStionable:CALibration:EVENt?      | Return value of the questionable calibration event register                                                        |
| STATus:QUEStionable:CALibration:NTRansition | Set/return the negative transition filter                                                                          |
| STATus:QUEStionable:CALibration:PTRansition | Set/return the positive transition filter                                                                          |
| SYSTem:BEEP[:ENABle]                        | Set/return keypad audible beeper status.<br><Boolean> = 0, 1, OFF, ON                                              |
| SYSTem:BEEP:IMMediate                       | Causes a beep to be emitted. No argument. No return.                                                               |
| SYSTem:COMMunicate:GPIB:ADDRess             | Set or return the GPIB bus address.<br><numeric value> = 1 to 30                                                   |
| SYSTem:COMMunicate:GPIB:EOI                 | Set/return the status of the GPIB EOI.<br><Boolean> = 0, 1, OFF, ON                                                |
| SYSTem:COMMunicate:GPIB:LISTen              | Set/return the GPIB Listen end-of-string terminator.<br><character data> = LF, CR, CRLF, EOIONLY                   |
| SYSTem:COMMunicate:GPIB:TALK                | Set/return the GPIB Talk end-of-string terminator.<br><character data> = LF, CR, CRLF, EOIONLY                     |
| SYSTem:COMMunicate:SERial:BAUD              | Set/return the RS232 baud rate.<br><numeric value> = 300, 600, 1200, 2400, 4800, 9600, 19200, 38400, 57600, 115200 |
| SYSTem:COMMunicate:SERial:BITS              | Set/return the RS232 serial Data Bits.<br><numeric value> = 7,8                                                    |
| SYSTem:COMMunicate:SERial:PARity            | Set/return the RS232 Parity.<br><character data> = ODD, EVEN, NONE                                                 |
| SYSTem:COMMunicate:SERial:SBITS             | Set/return the RS232 serial Stop Bits.<br><numeric value> = 1,2                                                    |
| SYSTem:ERRor[:NEXT]?                        | Return system error code and description                                                                           |
| SYSTem:ERRor:CODE?                          | Return system error code                                                                                           |
| SYSTem:ERRor:COUNT?                         | Return the number of errors in the queue                                                                           |
| SYSTem:PRESet                               | Set instrument to default conditions.                                                                              |
| SYSTem:VERSion?                             | Return SCPI version compliance.<br><numeric value> = yyyy.v                                                        |
| INSTrument:VERSion:FIRMWare?                | Returns the firmware revision code.<br><numeric value> = yyyyymmdd                                                 |
| INSTrument:VERSion:FPGA?                    | Returns the FPGA revision code.<br><numeric value> = MM.mm                                                         |

---

## Boonton 4240 Series RF Power Meter

### 5.5.16 4230 Emulation GPIB Commands

**Table 5-2. 4230 EMULATION GPIB COMMANDS**

| <b>Code</b> | <b>Description</b>                                  | <b>Comments</b>               |
|-------------|-----------------------------------------------------|-------------------------------|
| AM          | Measure A-B                                         |                               |
| AP          | Measure A + B                                       |                               |
| AR          | Measure A/B                                         |                               |
| BD          | Measure B - A                                       |                               |
| BR          | Measure B/A                                         |                               |
| BN          | 4230A Native mode                                   |                               |
| CH          | Channel select 1 - 2                                |                               |
| CF          | Calibrator off                                      |                               |
| CL          | Clear                                               |                               |
| CN          | Calibrator on                                       |                               |
| CP          | Calibrate                                           |                               |
| DB          | dBm select                                          |                               |
| DF          | Display off                                         |                               |
| DN          | Display on                                          |                               |
| DR          | dBr select                                          |                               |
| DU          | Display user message                                |                               |
| DY          | Duty cycle value                                    | 0.01 - 100.00 in 0.01 steps   |
| FA          | Auto filter                                         |                               |
| FD          | dB calibration factor                               | -3.00 to 3.00 in 0.01 steps   |
| FI          | Send high frequency calibration data to instrument  |                               |
| FL          | Filter time select                                  | 0 to 20.00 in 0.05 steps      |
| FO          | Get high frequency calibration data from instrument |                               |
| FR          | Frequency select                                    |                               |
| HPS         | Enable HP 437B emulation mode                       |                               |
| HPD         | Enable HP 438A emulation mode                       |                               |
| ?ID         | Talk instrument ID                                  |                               |
| *IDN?       | Talk instrument ID <sup>1</sup>                     |                               |
| LH          | High limit                                          | -99.99 to 99.99 in 0.01 steps |
| LL          | Low limit                                           | -99.99 to 99.99 in 0.01 steps |
| LM0         | Disable limits checking function                    |                               |
| LM1         | Enable limits checking function                     |                               |
| LR          | Load reference                                      |                               |

## Boonton 4240 Series RF Power Meter

**Table 5-2. 4230 EMULATION GPIB COMMANDS (continued)**

| Code | Description                             | Comments                      |
|------|-----------------------------------------|-------------------------------|
| MF   | Measure filtered                        |                               |
| MFD  | Measure Fast Dual Channels              |                               |
| MFS  | Measure fast single channel             |                               |
| MN   | Measure normal, free run                |                               |
| MS   | Measure settled                         |                               |
| OS   | Offset value                            | -99.99 to 99.99 in 0.01 steps |
| PW   | Watts select                            |                               |
| RA   | Autorange                               |                               |
| RB   | Recorder bottom                         |                               |
| RC   | Recall instrument configuration         | 1 - 10                        |
| RE   | Resolution                              | 1 - 3                         |
| RN   | Recorder normal                         |                               |
| RS   | Range select                            | 0 - 6                         |
| RT   | Recorder top                            |                               |
| SCPI | Set remote programming language to SCPI |                               |
| SI   | Send linearity data to instrument       |                               |
| SM   | Service request (SRQ) mask              | 0 - 255                       |
| SO   | Get linearity data from instrument      |                               |
| SR   | Set dBr reference                       | -99.99 to 99.99 in 0.01 steps |
| SS   | Sensor select                           | 1 - 6                         |
| ST   | Store instrument configuration          | 1 - 10                        |
| TF   | Trigger filtered                        |                               |
| TFD  | Trigger fast dual channels              |                               |
| TFS  | Trigger fast single channel             |                               |
| TN   | Trigger normal                          |                               |
| TM   | Talk mode                               | 0 - 6                         |
| TR   | Bus trigger                             |                               |
| TS   | Trigger settled                         |                               |
| ZR   | Instrument zero                         |                               |

1 The \* must be included as part of the GPIB command string.

# Boonton 4240 Series RF Power Meter

## 5.5.17 HP 437B Emulation GPIB Commands

**Table 5-3. HP 437B EMULATION GPIB COMMANDS**

| Code      | Description                                             | Comments      |
|-----------|---------------------------------------------------------|---------------|
| CL        | 0 dBm Calibration <sup>1</sup>                          |               |
| *CLS      | Clear the status register <sup>3</sup>                  |               |
| CS        | Clear the status byte                                   |               |
| CT0 - CT9 | Clear sensor data tables 0 - 9 <sup>1</sup>             | NOT SUPPORTED |
| DA        | All display segments on                                 |               |
| DC0       | Duty cycle on ('DY' ARG # 100)                          | NOT SUPPORTED |
| DC1       | Duty cycle off ('DY' ARG = 100)                         | NOT SUPPORTED |
| DD, DF    | Display disable                                         |               |
| DE        | Display enable                                          |               |
| DN        | Down arrow key                                          |               |
| DU        | Display user message                                    |               |
| DY        | Duty cycle value <sup>1</sup>                           |               |
| EN        | ENTER                                                   |               |
| ERR?      | Device error query                                      |               |
| *ESE      | Set event status enable mask <sup>3</sup>               |               |
| *ESE?     | Event status register query <sup>3</sup>                |               |
| *ESR?     | Event status register (ESR) query <sup>3</sup>          |               |
| ET0 - ET9 | Edit sensor calibration factor table 0 - 9 <sup>1</sup> | NOT SUPPORTED |
| EX        | EXIT                                                    |               |
| FA        | Automatic filter selection                              |               |
| FH        | Filter hold                                             |               |
| FM        | Manual filter selection <sup>1</sup>                    |               |
| FR        | Frequency entry <sup>1</sup>                            |               |
| GT0       | Ignore group execute trigger (GET) bus command          |               |
| GT1       | Trigger immediate response to GET command               |               |
| GT2       | Trigger with delay response to GET command              |               |
| GZ        | Gigahertz                                               |               |
| HZ        | Hertz                                                   |               |
| ID        | GPIB identification query                               |               |
| *IDN?     | GPIB identification query <sup>2</sup>                  |               |
| KB        | calibration factor <sub>1</sub> in percent              |               |



## Boonton 4240 Series RF Power Meter

**Table 5-3. HP 437B EMULATION GPIB COMMANDS**

| Code      | Description                                            | Comments      |
|-----------|--------------------------------------------------------|---------------|
| KZ        | Kilohertz                                              |               |
| LG        | Log display                                            |               |
| LH        | High limit <sup>1</sup>                                |               |
| LL        | Low limit <sup>1</sup>                                 |               |
| LM0       | Disable limits checking function                       |               |
| LM1       | Enable limits checking function                        |               |
| LN        | Linear display                                         |               |
| LP        | Learn Mode                                             | NOT SUPPORTED |
| LT        | Left arrow key                                         |               |
| MZ        | Megahertz                                              |               |
| OC0       | Reference oscillator off                               |               |
| OC1       | Reference oscillator on                                |               |
| OD        | Output display text                                    | NOT SUPPORTED |
| OF0       | Offset off <sup>4</sup>                                | NOT SUPPORTED |
| OF1       | Offset on <sup>4</sup>                                 | NOT SUPPORTED |
| OS        | Offset value <sup>1</sup>                              |               |
| PCT       | Percent                                                |               |
| PR        | Preset                                                 |               |
| RA        | Autorange                                              |               |
| RC        | RECALL <sup>1</sup>                                    | 1 - 10        |
| RE        | Resolution <sup>1</sup>                                | 1 - 3         |
| RF0 - RF9 | Enter sensor reference calibration factor <sup>1</sup> | NOT SUPPORTED |
| RH        | Range hold                                             |               |
| RL0       | Exit REL mode                                          |               |
| RL1       | Enter REL mode using new REL value                     |               |
| RL2       | Enter REL mode using old REF value                     |               |
| RM        | Set range <sup>1</sup>                                 |               |
| *RST      | Soft reset <sup>3</sup>                                |               |
| RT        | Right arrow key                                        |               |
| RV        | Read Service Request Mask value                        |               |
| SCPI      | Set remote programming language to SCPI                |               |
| SE        | Sensor number <sup>1</sup>                             | 1 - 6 only    |

# Boonton 4240 Series RF Power Meter

**Table 5-3. HP 437B EMULATION GPIB COMMANDS**

---

| <b>Code</b> | <b>Description</b>                        | <b>Comments</b> |
|-------------|-------------------------------------------|-----------------|
| SM          | Status message                            | NOT SUPPORTED   |
| SN0 - SN9   | Enter sensor serial number <sup>2</sup>   | NOT SUPPORTED   |
| SP - NOP    | SPECIAL                                   | NOT SUPPORTED   |
| *SRE        | Set the service request mask <sup>3</sup> |                 |
| *SRE?       | Service request mask query <sup>3</sup>   |                 |
| ST          | STORE <sup>1</sup>                        | 1 - 10          |
| *STB?       | Read the status byte                      |                 |
| TR0         | Trigger hold                              |                 |
| TR1         | Trigger immediate                         |                 |
| TR2         | Trigger with delay                        |                 |
| TR3         | Trigger-free run                          |                 |
| *TST?       | Self test query <sup>3</sup>              |                 |
| UP          | Up arrow key                              |                 |
| ZE          | ZERO                                      |                 |
| @1          | Set the service request mask              |                 |
| @2          | Learn mode prefix                         | NOT SUPPORTED   |
| %           | Percent                                   |                 |

---

1 A numeric entry is required by these GPIB codes, followed by the code EN (ENTER).

2 This GPIB code uses the next 6 characters (0 - 9, A - Z, or an underscore) as input data.

3 The \* must be included as part of the GPIB command string.

4 Offset value is always applied. Set the offset value to 0 dB for off condition. Any other value the offset is on.

# Boonton 4240 Series RF Power Meter

## 5.5.18 HP 438A Emulation GPIB Commands

**Table 5-4. HP 438A EMULATION GPIB COMMANDS**

| Code | Description                                                       | Comments                  |
|------|-------------------------------------------------------------------|---------------------------|
| AD   | Measure A-B                                                       |                           |
| AE   | Set A                                                             |                           |
| AP   | Measure sensor A                                                  |                           |
| AR   | Measure A/B                                                       |                           |
| BD   | Measure B-A                                                       |                           |
| BE   | Set B                                                             |                           |
| BP   | Measure sensor B                                                  |                           |
| BR   | Measure B/A                                                       |                           |
| CL   | CAL ADJ <sup>1,2</sup>                                            |                           |
| CS   | Clear status byte <sup>1</sup>                                    |                           |
| DA   | Display all <sup>1</sup>                                          |                           |
| DD   | Display disable <sup>1</sup>                                      |                           |
| DE   | Display enable <sup>1</sup>                                       |                           |
| DO   | Measured offset entry                                             |                           |
| EN   | ENTER <sup>1</sup>                                                |                           |
| FA   | Set auto average filtering                                        | (precede with AE or BE)   |
| FH   | Hold present average number                                       | (precede with AE or BE)   |
| FM   | Set filter number <sup>1,2</sup>                                  | (precede with AE or BE)   |
| GT0  | Group execute trigger cancel <sup>1</sup>                         |                           |
| GT1  | Group execute trigger single measurement <sup>1</sup>             |                           |
| GT2  | Group execute trigger full measurement with settling <sup>1</sup> |                           |
| GZ   | Gigahertz <sup>1</sup>                                            |                           |
| HZ   | Hertz <sup>1</sup>                                                |                           |
| ?ID  | Ask of ID <sup>1</sup>                                            |                           |
| KB   | Calibration factor <sup>1,2</sup>                                 |                           |
| KZ   | Kilohertz <sup>1</sup>                                            |                           |
| LG   | Set log units                                                     | (dB or dBm) <sup>1</sup>  |
| LH   | High limit <sup>1,2</sup>                                         |                           |
| LL   | Low limit <sup>1,2</sup>                                          |                           |
| LM0  | Disable limit checking <sup>1</sup>                               |                           |
| LM1  | Enable limit checking <sup>1</sup>                                |                           |
| LN   | Set linear units                                                  | (Watts or %) <sup>1</sup> |

## Boonton 4240 Series RF Power Meter

LP1 Set learn mode #1 NOT SUPPORTED

**Table 5-4. HP 438A EMULATION GPIB COMMANDS**

| Code | Description                                         | Comments                             |
|------|-----------------------------------------------------|--------------------------------------|
| LP2  | Set learn mode #2                                   | NOT SUPPORTED                        |
| MZ   | Megahertz <sup>1</sup>                              |                                      |
| OC0  | Turn off calibrator source <sup>1</sup>             |                                      |
| OC1  | Turn on calibrator source <sup>1</sup>              |                                      |
| OS   | Offset <sup>1,2</sup>                               |                                      |
| PR   | Preset instrument to a known state <sup>1</sup>     |                                      |
| RA   | Resume autorange <sup>1</sup>                       |                                      |
| RC   | RECALL <sup>1,2</sup>                               | 1 - 10                               |
| RH   | Range hold <sup>1</sup>                             |                                      |
| RL0  | Relative mode off <sup>1</sup>                      |                                      |
| RL1  | Relative mode on <sup>1</sup>                       |                                      |
| RL2  | Relative mode with old REL value <sup>1</sup>       |                                      |
| RM   | Set manual range <sup>1,2</sup>                     |                                      |
| RV   | Ask for status request mask <sup>1</sup>            |                                      |
| SCPI | Set remote programming language to SCPI             |                                      |
| SM   | Ask for status message <sup>1</sup>                 |                                      |
| ST   | STORE <sup>1,2</sup>                                | 1 - 10                               |
| TR0  | Trigger hold mode <sup>1</sup>                      |                                      |
| TR1  | Trigger single measurement <sup>1</sup>             |                                      |
| TR2  | Trigger full measurement with settling <sup>1</sup> |                                      |
| TR3  | Free run trigger mode <sup>1</sup>                  |                                      |
| ZE   | Zero sensor                                         | (precede with AE or BE) <sup>1</sup> |
| @1   | Prefix for service request mask <sup>1</sup>        |                                      |

1 These commands are fully compatible with the HP437B Power Meter command codes.

2 Requires numeric entry followed by program code EN.

## 6. Application Notes

This section provides supplementary material to enhance your knowledge of the 4240 Series' advanced features and measurement accuracy. Topics covered in this section include pulse measurement fundamentals, automatic measurement principles, and an analysis of measurement accuracy.

### 6.1 Pulse Measurements

#### 6.1.1 Measurements Fundamentals

The following is a brief review of power measurement fundamentals.

**Unmodulated Carrier Power.** The average power of an unmodulated carrier consisting of a continuous, constant amplitude sinusoidal signal is also termed CW power. For a known value of load impedance  $R$ , and applied voltage  $V_{rms}$ , the average power is:

$$P = V_{rms}^2/R \quad \text{watts}$$

Power meters designed to measure CW power can use thermoelectric detectors which respond to the heating effect of the signal or diode detectors which respond to the voltage of the signal. With careful calibration accurate measurements can be obtained over a wide range of input power levels.

**Modulated Carrier Power.** The average power of a modulated carrier which has varying amplitude can be measured accurately by a CW type power meter with a thermoelectric detector, but the lack of sensitivity will limit the range. Diode detectors can be used at low power, square-law response levels. At higher power levels the diode responds in a more linear manner and significant error results.

**Pulse Power.** Pulse power refers to power measured during the on time of pulsed RF signals (Figure 6-1). Traditionally, these signals have been measured in two steps: (1) thermoelectric sensors measure the average signal power, (2) the reading is then divided by the duty cycle to obtain pulse power,  $P_{pulse}$ :

$$P_{pulse} = \text{Average Power} / \text{Duty Cycle} \quad (\text{measured})$$

$$\text{where } \text{Duty Cycle} = \text{Pulse Width} / \text{Pulse Period}$$

Pulse power provides useful results when applied to rectangular pulses, but is inaccurate for pulse shapes that include distortions, such as overshoot or droop (Figure 6-2).

# Boonton 4240 Series RF Power Meter

Figure 6-1.  
Pulsed RF Signal

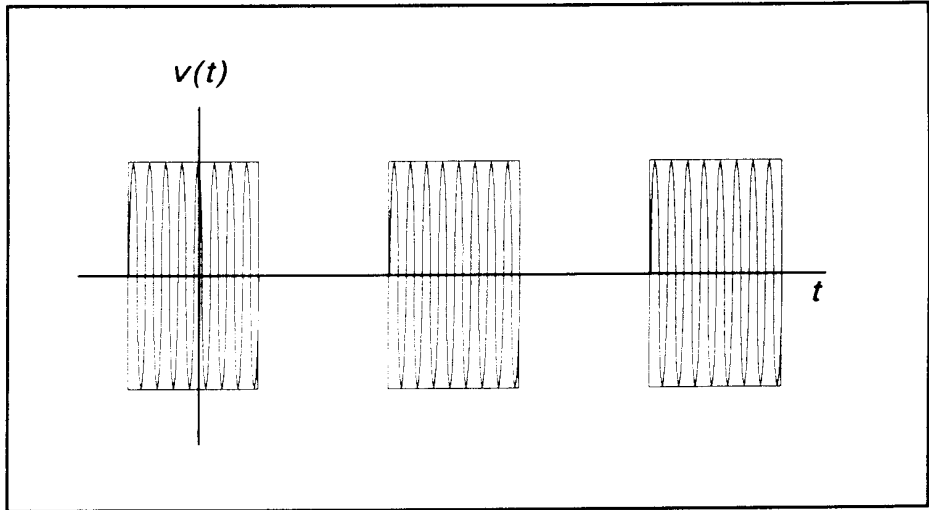
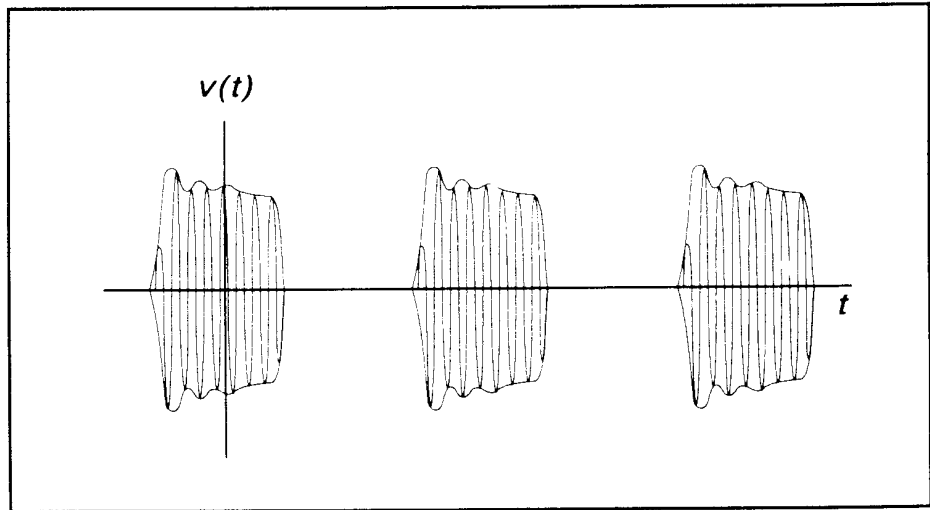

Figure 6-2.  
Distorted Pulse Signal



# Boonton 4240 Series RF Power Meter

## 6.1.2 Diode Detection

Wideband diode detectors are the dominant power sensing device used to measure pulsed RF signals. However, several diode characteristics must be compensated to make meaningful measurements. These include the detector's nonlinear amplitude response, temperature sensitivity, and frequency response characteristic. Additional potential error sources include detector mismatch, signal harmonics and noise.

**Detector Response.** The response of a single-diode detector to a sinusoidal input is given by the diode equation:

$$i = I_S \left( e^{\alpha v} - 1 \right)$$

where:

$i$  = diode current

$v$  = net voltage across the diode

$I_S$  = saturation current

$\alpha$  = constant

An ideal diode response curve is plotted in Figure 6-3.

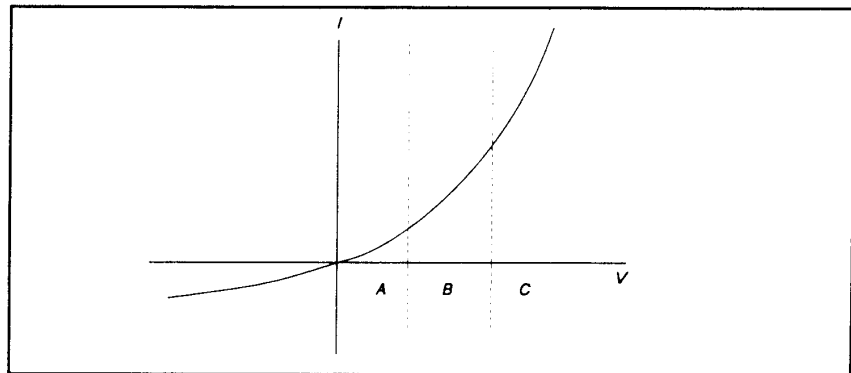

Figure 6-3.  
Ideal Diode Response

The curve indicates that for low microwave input levels (Region A), the single-diode detector output is proportional to the square of the input power. For high input signal levels (Region C), the output is linearly proportional to the input. In between these ranges (Region B), the detector response lies between square-law and linear.

For accurate power measurements over all three regions illustrated in Figure 6-3, the detector response is pre-calibrated over the entire range. The calibration data is stored in the instrument and recalled to adjust each sample of the pulse power measurement.

## Boonton 4240 Series RF Power Meter

**Frequency Response.** The carrier frequency response of a diode detector is determined mostly by the diode junction capacitance and the device lead inductances. Accordingly, the frequency response will vary from detector to detector and cannot be compensated readily. Power measurements must be corrected by constructing a frequency response calibration table for each detector.

**Mismatch.** Sensor impedance matching errors can contribute significantly to measurement uncertainty, depending on the mismatch between the device under test (DUT) and the sensor input. This error cannot be easily calibrated out, but can be minimized by employing an optimum matching circuit at the sensor input.

**Signal Harmonics.** Measurement errors resulting from harmonics of the carrier frequency are level-dependent and cannot be calibrated out. In the square-law region of the detector response (Region A, Figure 6-3), the signal and second harmonic combine on a root mean square basis. The effects of harmonics on measurement accuracy in this region are relatively insignificant. However, in the linear region (Region C, Figure 6-3), the detector responds to the vector sum of the signal and harmonics. Depending on the relative amplitude and phase relationships between the harmonics and the fundamental, measurement accuracy may be significantly degraded. Errors caused by even-order harmonics can be reduced by using balanced diode detectors for the power sensor. This design responds to the peak-to-peak amplitude of the signal, which remains constant for any phase relationship between fundamental and even-order harmonics. Unfortunately, for odd-order harmonics, the peak-to-peak signal amplitude is sensitive to phasing, and balanced detectors provide no harmonic error improvement.

**Noise.** For low-level signals, detector noise contributes to measurement uncertainty and cannot be calibrated out. Balanced detector sensors improve the signal-to-noise ratio by 3 dB, because the signal is twice as large.

### 6.1.3 4240 Series Features

The 4240 Series design incorporates several significant features to reduce measurement error, simplify operation, and speed internal processing. These features include:

- *Balanced diode sensors* enhance error performance by increasing signal-to-noise and suppressing even-order signal harmonics.
- *Smart Sensors* (sensor-mounted EEPROM) store sensor frequency calibration eliminating operator entry.
- *Digital Signal Processor* provides fast processing for near real-time measurements.
- *A built-in programmable calibrator* which creates a unique calibration table for each sensor.



# Boonton 4240 Series RF Power Meter

## 6.2 Measurement Accuracy

The 4240 Series includes a precision, internal, 50 MHz RF reference calibrator that is traceable to the National Institute for Standards and Technology (NIST). When the instrument is maintained according to the factory recommended one year calibration cycle, the calibrator enables you to make highly precise measurements of CW signals. The error analyses in this chapter assumes that the power meter is being maintained correctly and is within its valid calibration period.

Measurement uncertainties are attributable to the instrument, calibrator, sensor, and impedance mismatch between the sensor and the device under test (DUT). Individual independent contributions from each of these sources are combined mathematically to quantify the upper error bound and probable error. The probable error is obtained by combining the linear (percent) sources on a root-sum-of-squares (RSS) basis. RSS uncertainty calculations also take into account the statistical shape of the expected error distribution.

Note that uncertainty figures for individual components may be provided given in either percent or dB. The following formulas may be used to convert between the two units:

$$U_{\%} = (10^{(U_{dB}/10)} - 1) \times 100 \quad \text{and} \quad U_{dB} = 10 \times \text{Log}_{10}(1 + (U_{\%}/100))$$

Section 6.2.1 outlines all the parameters that contribute to the power measurement uncertainty followed by a discussion on the method and calculations used to express the uncertainty.

Section 6.2.2 continues discussing each of the uncertainty terms in more detail while presenting some of their values.

Section 6.2.3 provides Power Measurement Uncertainty calculation example for a CW Power sensors with complete Uncertainty Budgets.

### 6.2.1 Uncertainty Contributions.

The total measurement uncertainty is calculated by combining the following terms:

| <u>Uncertainty Source</u>                | <u>Distribution Shape</u> | <u>K</u> |
|------------------------------------------|---------------------------|----------|
| 1. Instrument Uncertainty                | Normal                    | 0.500    |
| 2. Calibrator Level Uncertainty          | Rectangular               | 0.577    |
| 3. Calibrator Mismatch Uncertainty       | U-shaped                  | 0.707    |
| 4. Source Mismatch Uncertainty           | U-shaped                  | 0.707    |
| 5. Sensor Shaping Error                  | Rectangular               | 0.577    |
| 6. Sensor Temperature Coefficient        | Rectangular               | 0.577    |
| 7. Sensor Noise                          | Normal                    | 0.500    |
| 8. Sensor Zero Drift                     | Rectangular               | 0.577    |
| 9. Sensor Calibration Factor Uncertainty | Normal                    | 0.500    |

The formula for worst-case measurement uncertainty is:

$$U_{\text{WorstCase}} = U_1 + U_2 + U_3 + U_4 + \dots U_N$$

where  $U_1$  through  $U_N$  represent each of the worst-case uncertainty terms.

# Boonton 4240 Series RF Power Meter

The worst case approach is a very conservative method in which the extreme conditions of each of the individual uncertainties are added together. If the individual uncertainties are all independent of one another, the probability of all being at their worst-case conditions simultaneously is extremely small. For this reason, the uncertainties are more commonly combined using the RSS method. RSS is an abbreviation for “root-sum-of-squares”, a technique in which each uncertainty is squared, the squares are summed, and the square root of the summation is calculated.

Before the RSS calculation can be performed, however, the worst-case uncertainty values must be scaled, or “normalized” to adjust for differences in each term’s probability distribution or “shape”. The distribution shape is a statistical description of how the actual error values are likely to vary from the ideal value. Once normalized in this way, terms with different distribution shapes can be combined freely using the RSS method.

Three main types of distributions are Normal (Gaussian), Rectangular, and U-shaped. The multipliers for each type of distribution are as follows:

| <u>Distribution</u> | <u>Multiplier “K”</u>      |
|---------------------|----------------------------|
| Normal              | 0.500                      |
| Rectangular         | $\text{sqrt}(1/3) = 0.577$ |
| U-shaped            | $\text{sqrt}(1/2) = 0.707$ |

The formula for calculating RSS measurement uncertainty from worst-case values and scale factors is:

$$U_{\text{RSS}} = \sqrt{(U_1 K_1)^2 + (U_2 K_2)^2 + (U_3 K_3)^2 + (U_4 K_4)^2 + \dots + (U_N K_N)^2}$$

where  $U_1$  through  $U_N$  represent each of the worst-case uncertainty terms, and  $K_1$  through  $K_N$  represent the normalizing multipliers for each term based on its distribution shape.

This calculation yields what is commonly referred to as the combined standard uncertainty, or  $U_c$ , with a level of confidence of approximately 68%. To gain higher levels of confidence an Expanded Uncertainty is often employed. Using a coverage factor of 2 ( $U = 2U_c$ ) will provide an Expanded Uncertainty with a confidence level of approximately 95%.

## 6.2.2 Discussion of Uncertainty Terms.

Following is a discussion of each term, its definition, and how it is calculated.

**Instrument Uncertainty.** This term represents the amplification and digitization uncertainty in the power meter, as well as internal component temperature drift. In most cases, this is very small, since absolute errors in the circuitry are calibrated out by the AutoCal process. The instrument uncertainty is 0.23% for the 4240 Series.

**Calibrator Level Uncertainty.** This term is the uncertainty in the calibrator’s output level for a given setting for calibrators that are maintained in calibrated condition. The figure is a calibrator specification which depends upon the output level:

50MHz Calibrator Level Uncertainty:

At 0 dBm:  $\pm 0.055$  dB (1.27%)

+20 to -39 dBm:  $\pm 0.075$  dB (1.74%)

-40 to -60 dBm:  $\pm 0.105$  dB (2.45%)

# Boonton 4240 Series RF Power Meter

The value to use for calibration level uncertainty depends upon the sensor calibration technique used. If AutoCal was performed, the calibrator's uncertainty at the measurement power level should be used. For sensors calibrated with FixedCal, the calibrator is only used as a single-level source, and you should use the calibrator's uncertainty at the FixedCal level, (0dBm, for most sensors). This may make FixedCal seem *more accurate* than AutoCal at some levels, but this is usually more than offset by the reduction in shaping error afforded by the AutoCal technique.

**Calibrator Mismatch Uncertainty.** This term is the mismatch error caused by impedance differences between the calibrator output and the sensor's termination. It is calculated from the reflection coefficients of the calibrator ( $\rho_{CAL}$ ) and sensor ( $\rho_{SNSR}$ ) at the calibration frequency with the following equation:

$$\text{Calibrator Mismatch Uncertainty} = \pm 2 \times \rho_{CAL} \times \rho_{SNSR} \times 100 \%$$

The calibrator reflection coefficient is a calibrator specification:

$$50 \text{ MHz Calibrator Reflection Coefficient } (\rho_{CAL}): \quad 0.024 \text{ (at 50MHz)}$$

The sensor reflection coefficient,  $\rho_{SNSR}$  is frequency dependent, and may be looked up in the sensor datasheet or the *Boonton Electronics Power Sensor Manual*.

**Source Mismatch Uncertainty.** This term is the mismatch error caused by impedance differences between the measurement source output and the sensor's termination. It is calculated from the reflection coefficients of the source ( $\rho_{SRCE}$ ) and sensor ( $\rho_{SNSR}$ ) at the measurement frequency with the following equation:

$$\text{Source Mismatch Uncertainty} = \pm 2 \times \rho_{SRCE} \times \rho_{SNSR} \times 100 \%$$

The source reflection coefficient is a characteristic of the RF source under test. If only the SWR of the source is known, its reflection coefficient may be calculated from the source SWR using the following equation:

$$\text{Source Reflection Coefficient } (\rho_{SRCE}) = (\text{SWR} - 1) / (\text{SWR} + 1)$$

The sensor reflection coefficient,  $\rho_{SNSR}$  is frequency dependent, and may be looked up in the sensor datasheet or the *Boonton Electronics Power Sensor Manual*. For most measurements, this is the single largest error term, and care should be used to ensure the best possible match between source and sensor.

**Sensor Shaping Error.** This term is sometimes called "linearity error", and is the residual non-linearity in the measurement after an *AutoCal* has been performed to characterize the "transfer function" of the sensor (the relationship between applied RF power, and sensor output, or "shaping"). Calibration is performed at discrete level steps and is extended to all levels. Generally, sensor shaping error is close to zero at the autocal points, and increases in between due to imperfections in the curve-fitting algorithm.

An additional component of sensor shaping error is due to the fact that the sensor's transfer function may not be identical at all frequencies. The published shaping error includes terms to account for these deviations. If your measurement frequency is close to your AutoCal frequency, it is probably acceptable to use a value lower than the published uncertainty in your calculations.

For CW sensors using the fixed-cal method of calibrating, the shaping error is higher because it relies upon stored "shaping coefficients" from a factory calibration to describe the shape of the transfer function, rather than a transfer calibration using a precision power reference at the current time and temperature. For this reason, use of the AutoCal method is recommended for CW sensors rather than simply performing a FixedCal. The shaping error for CW sensors using the FixedCal calibration method is listed as part of the "Sensor Characteristics" outlined in Section 2 of the *Boonton Electronics Power Sensor Manual*. If the AutoCal calibration method is used with a CW sensor, a fixed value of 1.0% may be used for all signal levels.

## Boonton 4240 Series RF Power Meter

**Sensor Temperature Coefficient.** This term is the error which occurs when the sensor's temperature has changed significantly from the temperature at which the sensor was AutoCal'd. Refer to the *Boonton Electronics Power Sensor Manual* for the Temperature Coefficient for the sensor being used.

**Sensor Noise.** For CW measurements it depends on the integration time of the measurement, which is set by the "AVG" menu setting. In general, increasing averaging reduces measurement noise. Sensor noise is typically expressed as an absolute power level. The uncertainty due to noise depends upon the ratio of the noise to the signal power being measured. The following expression is used to calculate uncertainty due to noise:

$$\text{Noise Error} = \pm \text{Sensor Noise (in watts)} / \text{Signal Power (in watts)} \times 100 \%$$

The noise rating of a particular power sensor may be found on the sensor datasheet, or the *Boonton Electronics Power Sensor Manual*. It may be necessary to adjust the sensor noise for more or less averaging, depending upon the application. As a general rule (within a decade of the datasheet point), noise is inversely proportional to the filter time or averaging used. Noise error is usually insignificant when measuring at high levels (25dB or more above the sensor's minimum power rating).

**Sensor Zero Drift.** Zero drift is the long-term change in the zero-power reading that is not a random, noise component. Increasing averaging will not reduce zero drift. For low-level measurements, this can be controlled by zeroing the meter just before performing the measurement. Zero drift is typically expressed as an absolute power level, and its error contribution may be calculated with the following formula:

$$\text{Zero Drift Error} = \pm \text{Sensor Zero Drift (in watts)} / \text{Signal Power (in watts)} \times 100 \%$$

The zero drift rating of a particular power sensor may be found on the sensor datasheet, or the *Boonton Electronics Power Sensor Manual*. Zero drift error is usually insignificant when measuring at high levels (25dB or more above the sensor's minimum power rating). The drift specification usually indicates a time interval such as one hour. If the time since performing a sensor Zero or AutoCal is very short, the zero drift is greatly reduced.

**Sensor Calibration Factor Uncertainty.** Sensor frequency calibration factors ("calfactors") are used to correct for sensor frequency response deviations. These calfactors are characterized during factory calibration of each sensor by measuring its output at a series of test frequencies spanning its full operating range, and storing the ratio of the actual applied power to the measured power at each frequency. This ratio is called a calfactor. During measurement operation, the power reading is multiplied by the calfactor for the current measurement frequency to correct the reading for a flat response.

The sensor calfactor uncertainty is due to uncertainties encountered while performing this frequency calibration (due to both standards uncertainty, and measurement uncertainty), and is different for each frequency. Both worst case and RSS uncertainties are provided for the frequency range covered by each sensor, and are listed on the sensor datasheet and in the *Boonton Electronics Power Sensor Manual*.

If the measurement frequency is between sensor calfactor entries, the most conservative approach is to use the higher of the two corresponding uncertainty figures. It is also possible to estimate the figure by linear interpolation.

If the measurement frequency is identical to the AutoCal frequency, a calfactor uncertainty of zero should be used, since any absolute error in the calfactor cancels out during AutoCal. At frequencies that are close to the AutoCal frequency, the calfactor uncertainty is only partially cancelled out during AutoCal, so it is generally acceptable to take the uncertainty for the next closest frequency, and scale it down.

# Boonton 4240 Series RF Power Meter

## 6.2.3 Sample Uncertainty Calculations.

The following example shows calculations for a CW power sensors. The figures used in these examples are meant to show the general technique, and do not apply to every application. Some “common sense” assumptions have been made to illustrate the fact that uncertainty calculation is not an exact science, and requires some understanding of your specific measurement conditions.

### Typical Example #1: Model 51075 CW Power Sensor

4240 Series measurement conditions:

|                      |                                                |
|----------------------|------------------------------------------------|
| Source Frequency:    | 10.3 GHz                                       |
| Source Power:        | -55 dBm (3.16 nW)                              |
| Source SWR :         | .50 (reflection coefficient = 0.2) at 10.3 GHz |
| AutoCal Source:      | Internal 50MHz Calibrator                      |
| AutoCal Temperature: | 25C                                            |
| Current Temperature: | 25C                                            |

In this example, we will assume that an AutoCal has been performed on the sensor immediately before the measurement. This will reduce certain uncertainty terms, as discussed below.

**Step 1:** The Instrument Uncertainty figure for the 4240 Series is  $\pm 0.23\%$ . Since a portion of this figure is meant to include temperature drift of the instrument, and we know an AutoCal has just been performed, we'll estimate (for lack of more detailed, published information) that the instrument uncertainty is  $\pm 0.115\%$ , or half the published figure.

$$U_{\text{Instrument}} = \pm 0.115\%$$

**Step 2:** The Calibrator Level Uncertainty for the power meter's 50MHz calibrator may be read from the calibrator's specification. It is  $\pm 0.105\text{dB}$ , or  $\pm 2.45\%$  at a level of -55dBm.

$$U_{\text{CalLevel}} = \pm 2.45\%$$

**Step 3:** The Calibrator Mismatch Uncertainty is calculated using the formula in the previous section, using the 50MHz calibrator's published figure for  $\rho_{\text{CAL}}$  and calculating the value  $\rho_{\text{SNSR}}$  from the SWR specification on the 51075's datasheet.

$$\rho_{\text{CAL}} = 0.024 \text{ (calibrator's reflection coefficient at 50MHz)}$$

$$\rho_{\text{SNSR}} = (1.15 - 1) / (1.15 + 1) = 0.070 \text{ (calculate reflection coefficient of 51075, max SWR = 1.15 at 50MHz)}$$

$$\begin{aligned} U_{\text{CalMismatch}} &= \pm 2 \times \rho_{\text{CAL}} \times \rho_{\text{SNSR}} \times 100 \% \\ &= \pm 2 \times 0.024 \times 0.070 \times 100 \% \\ &= \pm 0.34\% \end{aligned}$$

**Step 4:** The Source Mismatch Uncertainty is calculated using the formula in the previous section, using the DUT's specification for  $\rho_{\text{SRCE}}$  and calculating the value  $\rho_{\text{SNSR}}$  from the SWR specification on the 51075's datasheet.

$$\rho_{\text{SRCE}} = 0.20 \text{ (source reflection coefficient at 10.3GHz)}$$

$$\rho_{\text{SNSR}} = (1.40 - 1) / (1.40 + 1) = 0.167 \text{ (calculate reflection coefficient of 51075, max SWR = 1.40 at 10.3GHz)}$$

$$\begin{aligned} U_{\text{SourceMismatch}} &= \pm 2 \times \rho_{\text{SRCE}} \times \rho_{\text{SNSR}} \times 100 \% \\ &= \pm 2 \times 0.20 \times 0.167 \times 100 \% \\ &= \pm 6.68\% \end{aligned}$$

**Step 5:** The uncertainty caused by Sensor Shaping Error for a 51075 CW sensor that has been calibrated using the AutoCal method can be assumed to be 1.0%, as per the discussion in the previous section.

$$U_{\text{ShapingError}} = \pm 1.0 \%$$

## Boonton 4240 Series RF Power Meter

**Step 6:** The Sensor Temperature Drift Error depends on how far the temperature has drifted from the sensor calibration temperature, and the temperature coefficient of the sensor. In this example, an AutoCal has just been performed on the sensor, and the temperature has not drifted at all, so we can assume a value of zero for sensor temperature drift uncertainty.

$$U_{\text{SnsrTempDrift}} = \pm 0.0 \%$$

**Step 7:** This is a relatively low-level measurement, so the noise contribution of the sensor must be included in the uncertainty calculations. We'll assume default filtering. The signal level is -55dBm, or 3.16nW. The RMS noise specification for the 51075 sensor is 30pW, from the sensor's datasheet. Noise uncertainty is the ratio of these two figures.

$$\begin{aligned} U_{\text{Noise Error}} &= \pm (\text{Sensor Noise (in watts)} / \text{Signal Power (in watts)}) \times 100\% \\ &= \pm (30.0\text{e-}12 / 3.16\text{e-}9) \times 100 \% \\ &= \pm 0.95\% \end{aligned}$$

**Step 8:** The Sensor Zero Drift calculation is very similar to the noise calculation. For sensor zero drift, the datasheet specification for the 51075 sensor is 100pW, so we'll take the liberty of cutting this in half to 50pW, since we just performed an AutoCal, and it's likely that the sensor hasn't drifted much.

$$\begin{aligned} U_{\text{Zero Drift}} &= \pm (\text{Sensor Zero Drift (in watts)} / \text{Signal Power (in watts)}) \times 100\% \\ &= \pm (50.0\text{e-}12 / 3.16\text{e-}9) \times 100 \% \\ &= \pm 1.58\% \end{aligned}$$

**Step 9:** The Sensor Calfactor Uncertainty is calculated from the uncertainty values in the *Boonton Electronics Power Sensor Manual*. There is no entry for 10.3GHz, so we'll have to look at the two closest entries. At 10GHz, the calfactor uncertainty is 4.0%, and at 11GHz it is 4.3%. These two values are fairly close, so we'll perform a linear interpolation to estimate the uncertainty at 10.3GHz:

$$\begin{aligned} U_{\text{CalFactor}} &= [ ( F - F1 ) * (( CF2 - CF1 ) / ( F2 - F1 )) ] + CF1 \\ &= [ ( 10.3 - 10.0 ) * (( 4.3 - 4.0 ) / ( 11.0 - 10.0 )) ] + 4.0 \\ &= 4.09\% \end{aligned}$$

## Boonton 4240 Series RF Power Meter

**Step 10:** Now that each of the individual uncertainty terms has been determined, we can combine them to calculate the worst-case and RSS uncertainty values:

|                                                            | <b>U (±%)</b> | <b>K</b> | <b>(U×K)<sup>2</sup> ( %<sup>2</sup>)</b> |
|------------------------------------------------------------|---------------|----------|-------------------------------------------|
| 1. instrument uncertainty                                  | 0.115         | 0.500    | 0.0033                                    |
| 2. calibrator level uncertainty                            | 2.45          | 0.577    | 1.9984                                    |
| 3. calibrator mismatch uncertainty                         | 0.34          | 0.707    | 0.0578                                    |
| 4. source mismatch uncertainty                             | 6.68          | 0.707    | 22.305                                    |
| 5. sensor shaping error uncertainty                        | 1.00          | 0.577    | 0.3333                                    |
| 6. sensor temperature drift uncertainty                    | 0.00          | 0.577    | 0.0000                                    |
| 7. sensor noise uncertainty                                | 0.95          | 0.500    | 0.2256                                    |
| 8. sensor zero drift uncertainty                           | 1.58          | 0.577    | 0.8311                                    |
| 9. sensor calibration factor uncertainty                   | 4.09          | 0.500    | 4.1820                                    |
| <b>Total worst case uncertainty: ±17.21%</b>               |               |          |                                           |
| Total sum of squares:                                      |               |          | 29.937 % <sup>2</sup>                     |
| <b>Combined Standard uncertainty U<sub>c</sub> (RSS) :</b> |               |          | <b>±5.47 %</b>                            |
| <b>Expanded Uncertainty U (coverage factor k = 2) :</b>    |               |          | <b>±10.94 %</b>                           |

From this example, it can be seen that the two largest contributions to total uncertainty are the source mismatch, and the sensor calfactor. Also note that the expanded uncertainty is approximately one-half the value of the worst-case uncertainty. This is not surprising, since the majority of the uncertainty comes from just two sources. If the measurement frequency was lower, these two terms would be reduced, and the expanded uncertainty would probably be less than half the worst-case. Conversely, if one term dominated (for example if a very low level measurement was being performed, and the noise uncertainty was 30%), the expanded uncertainty value would be expected to approach the worst-case value. The expanded uncertainty is 0.45 dB.

It should be noted that measurement uncertainty calculation is a very complex process, and the techniques shown here are somewhat simplified to allow easier calculation. For a more complete information, the following publications may be consulted:

1. “ISO Guide to the Expression of Uncertainty in Measurement” (1995)  
International Organization for Standardization, Geneva, Switzerland  
ISBN 92-67-10188-9
2. “U.S. Guide to the Expression of Uncertainty in Measurement” (1996)  
National Conference of Standards Laboratories, Boulder, CO 80301  
ANSI/NCSL Z540-2-1996

## Boonton 4240 Series RF Power Meter

This page intentionally left blank.



## 7. Maintenance

---

This section presents procedures for maintaining the 4240 Series.

### 7.1 Safety

Although the 4240 Series has been designed in accordance with international safety standards, general safety precautions must be observed during all phases of operation and maintenance. Failure to comply with the precautions listed in the **Safety Summary** located in the front of this manual could result in serious injury or death. Service and adjustments should be performed only by qualified service personnel.

### 7.2 Cleaning

Painted surfaces can be cleaned with a commercial spray-type window cleaner or a mild detergent and water solution.

#### CAUTION



Avoid using chemical cleaning agents which can damage painted or plastic surfaces.

### 7.3 Inspection

If a 4240 Series instrument malfunctions, perform a visual inspection of the instrument. Inspect for signs of damage caused by excessive shock, vibration or overheating. Inspect for broken wires, loose electrical connections, or accumulations of dust or other foreign matter.

Correct any problems you discover and conduct a performance test to verify that the instrument is operational. If the malfunction persists or the instrument fails the performance verification, contact Boonton Electronics for service.

### 7.4 Firmware Upgrade

Operating Firmware has been loaded into the 4240 Series instrument at the factory. The Firmware will be updated from time to time to correct errors and add new features. Users can upgrade their firmware by downloading a special Firmware Upgrade file from the Boonton Electronics webpage, [www.boonton.com](http://www.boonton.com).

# Boonton 4240 Series RF Power Meter

## 7.5 Firmware Upgrade Instructions

### Requirements

The Firmware Update file is a text file in S-record format. Any utility that can send a text file over the GPIB interface could be used, however, it is recommended that National Instruments VISA Interactive Controller (VIC) utility that is available with installation of their VISA (Virtual Instrument Software Architecture) product be used as this has been tried and tested. Please refer to the specific vendor's website for license and download details.

### Procedure

1. Save the file "Srecord\_4240.hex" to your hard drive in a folder such as "C:\4240\Update"
2. On the 4240 configure the following IEEE parameters as shown;  
EMULATION 4230  
EOS LSTN LF
3. Start the VISA Interactive Controller utility

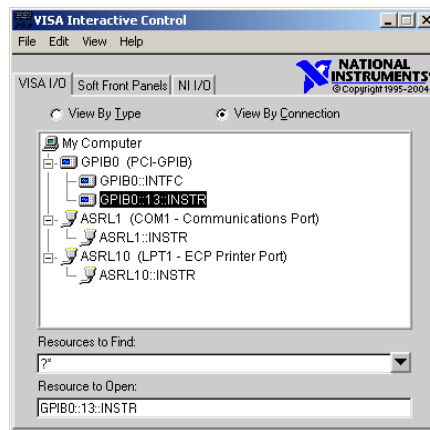

4. Double click on the 4240 Resource (in this example 'GPIB0::13::INSTR') to open a VISA Session. Ensure that the 'Show All VISA Operations' box is checked. Then click the 'Basic I/O' tab and then the 'viWriteFromFile' tab on that form.
5. Set the count to 2000000 then either Browse for or enter the Filename.

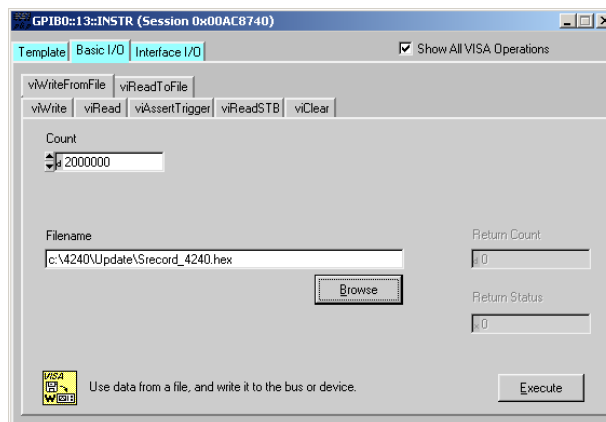

6. Click the 'Execute' button to send the file to the instrument.

## Boonton 4240 Series RF Power Meter

7. During this time the 4240 will display "FIRMWARE DOWNLOAD". The download takes approximate 45 seconds to completely transfer.
  8. When the End-Of-File is reached the message "PROGRAMMING FLASH" will be displayed on the 4240. Flash programming takes approximately 5 seconds to complete.
  9. When programming is complete the instrument returns to the measurement display.
  10. At this time cycle the power to the instrument to run the new firmware.
  11. Note the 'Rev.' number should indicate the latest revision. For example: 20100717.
-

## Boonton 4240 Series RF Power Meter

This page intentionally left blank.

## 8. Appendix A SCPI Error Messages

---

### 8.1 SCPI Error Messages

| NO.  | MESSAGE                   | DESCRIPTION                                                           |
|------|---------------------------|-----------------------------------------------------------------------|
| 0    | "No Error"                |                                                                       |
| -100 | "Command Error"           |                                                                       |
| -101 | "SubCmd not found"        |                                                                       |
| -102 | "Syntax error"            |                                                                       |
| -103 | "Too many qry"            |                                                                       |
| -108 | "Parameter not allowed"   |                                                                       |
| -109 | "Missing parameter"       |                                                                       |
| -113 | "Undefined header"        |                                                                       |
| -115 | "Channel out of range"    |                                                                       |
| -121 | "Invalid argument"        |                                                                       |
| -131 | "Invalid suffix"          |                                                                       |
| -200 | "Execution error"         |                                                                       |
| -213 | "Init ignored"            |                                                                       |
| -221 | "Settings conflict"       |                                                                       |
| -222 | "Data out of range"       |                                                                       |
| -224 | "Illegal parameter value" |                                                                       |
| -227 | "CAL Level > Limit"       | Attempt to set the calibrator level greater than the Max Power level. |
| -240 | "Hardware Error"          |                                                                       |
| -241 | "Error hardware missing"  |                                                                       |
| -242 | "CH2 Not Responding"      | Channel 2 is not responding to instrument control.                    |
| -243 | "CH1 Not Responding"      | Channel 1 is not responding to instrument control.                    |
| -244 | "No channel responding"   | CH1 and CH2 do not respond to instrument control.                     |

## Boonton 4240 Series RF Power Meter

| NO.  | MESSAGE                            | DESCRIPTION                                                  |
|------|------------------------------------|--------------------------------------------------------------|
| -245 | "Sensor Disconnected."             |                                                              |
| -246 | "Sensor voltage error"             |                                                              |
| -247 | "No Calibrator"                    | The calibrator is not responding to instrument control.      |
| -248 | "Keyboard error"                   |                                                              |
| -249 | "FPGA download err"                |                                                              |
| -263 | "MFS Init"                         |                                                              |
| -264 | "Flash init"                       |                                                              |
| -266 | "Mem restore"                      |                                                              |
| -280 | "Program error"                    |                                                              |
| -295 | "Command not in language."         |                                                              |
| -296 | "Data out of range, set to limit." |                                                              |
| -297 | "Command not supported."           |                                                              |
| -313 | "Cal mem lost"                     |                                                              |
| -340 | "Calibration failed"               |                                                              |
| -350 | "Error queue overflow"             |                                                              |
| -360 | "Communication Error"              |                                                              |
| -362 | "Snsr2 Page Blank"                 |                                                              |
| -363 | "Snsr1 Page Blank"                 |                                                              |
| -364 | "Sensor access fault"              |                                                              |
| -371 | "Err CH2 Sensor Data"              | Checksum failure of the Channel 2 sensor EEPROM.             |
| -372 | "Err CH1 Sensor Data"              | Checksum failure of the Channel 1 sensor EEPROM .            |
| -373 | "Measurement Error"                |                                                              |
| -375 | "Cmd not accepted"                 |                                                              |
| -376 | "I2C Timeout"                      | Software has timed-out while communicating over the I2C bus. |
| -377 | "No I2C Ack"                       | Missing Acknowledge signal while assessing the I2C bus.      |
| -397 | "Err CW signal."                   |                                                              |

---

# 9. Appendix B Warranty & Repair

---

## Repair Policy

### **4240 Series Instrument.**

If the Boonton 4240 Series RF Power Meter is not operating correctly and requires service, contact the Boonton Electronics Service Department for return authorization. You will be provided with an RMA number and shipping instructions. Customers outside the USA should contact the authorized Boonton distributor for your area. The entire instrument must be returned in its original packing container. If the original container is not available, Boonton Electronics will ship a replacement container and you will be billed for the container cost and shipping charges. See section 2.1 of this manual for packing instructions.

### **Boonton Power Sensors.**

Damaged or defective peak power sensors are repaired as separate accessories. Note that sensors which have failed due to overloading, improper mating, or connecting to an out-of-tolerance connector are not considered defective and will not be covered by the Boonton Warranty. If repair is needed, contact the Boonton Electronics Service Department for return authorization. You will be provided with an RMA number and shipping instructions. Customers outside the USA should contact the authorized Boonton distributor for your area. Only the defective sensor should be returned to Boonton, not the entire instrument. The sensor must be returned in its original packing container. If the original container is not available, Boonton Electronics will ship a replacement container and you will be billed for the container cost and shipping charges. If a new sensor is ordered, note that it does not include a sensor cable - this item must be ordered separately.

### **Contacting Boonton.**

Customers in the United States having questions or equipment problems may contact Boonton Electronics directly during business hours (8 AM to 5 PM Eastern) by phoning (973) 386-9696. FAX messages may be sent at any time to (973) 386-9191. E-mail inquiries should be sent to [service@boonton.com](mailto:service@boonton.com). International customers should contact their authorized Boonton Electronics representative for assistance. A current list of authorized US and international representatives is available on the Boonton website at [www.boonton.com](http://www.boonton.com).

## Limited Warranty

Boonton Electronics warrants its products to the original Purchaser to be free from defects in material and workmanship and to operate within applicable specifications for a period of one year from date of shipment for instruments, probes, power sensors and accessories. Boonton Electronics further warrants that its instruments will perform within all current specifications under normal use and service for one year from date of shipment. These warranties do not cover active devices that have given normal service, sealed assemblies which have been opened, or any item which has been repaired or altered without Boonton's authorization.

Boonton's warranties are limited to either the repair or replacement, at Boonton's option, of any product found to be defective under the terms of these warranties.

There will be no charge for parts and labor during the warranty period. The Purchaser shall prepay inbound shipping charges to Boonton or its designated service facility and shall return the product in its original or an equivalent shipping container. Boonton or its designated service facility shall pay shipping charges to return the product to the Purchaser for domestic shipping addresses. For addresses outside the United States, the Purchaser is responsible for prepaying all shipping charges, duties and taxes (both inbound and outbound).

*At Boonton's option, an extended Warranty period may be available for an additional charge. If an extended warranty option has been purchased, the extended period is substituted for the 1 year period above. Note that the extended warranty does not extend the instrument's calibration interval past 12 months. The instrument must be maintained in a calibrated state throughout the warranty period to be eligible for warranty service to remedy "out of spec" operation.*

## Boonton 4240 Series RF Power Meter

THE FOREGOING WARRANTIES ARE IN LIEU OF ALL OTHER WARRANTIES, EXPRESS OR IMPLIED, INCLUDING, BUT NOT LIMITED TO, THE IMPLIED WARRANTIES OF MERCHANTABILITY AND FITNESS FOR A PARTICULAR PURPOSE. Boonton will not be liable for any incidental damages or for any consequential damages, as defined in Section 2-715 of the Uniform Commercial Code, in connection with products covered by the foregoing warranties.

---

**END OF 4240 SERIES MANUAL**